

Balancing Scale - Metric Units

MS2

Calculate the unknown weight to balance each scale.

1)

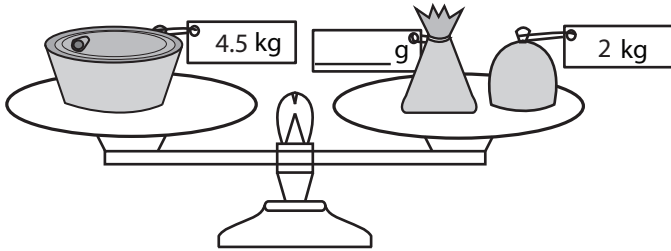

2)

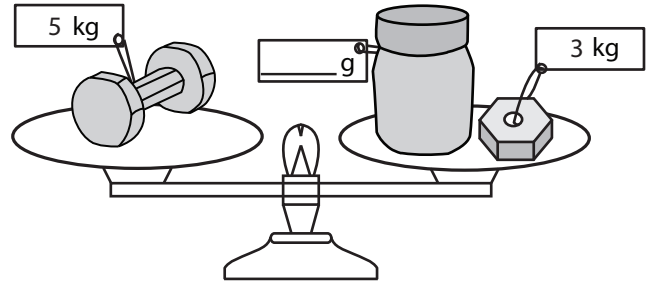

3)

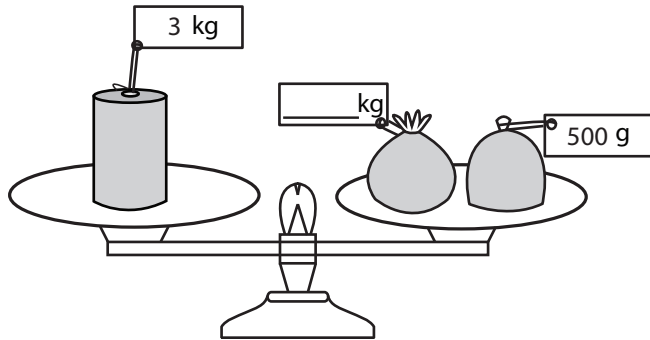

4)

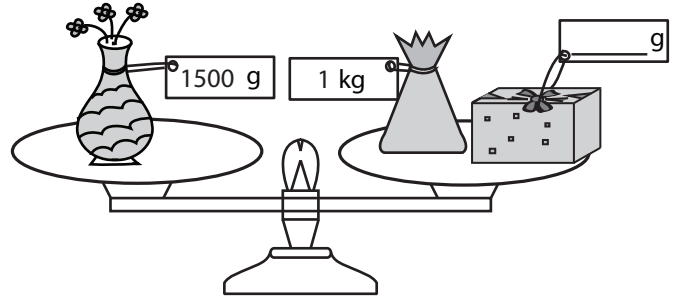

5)

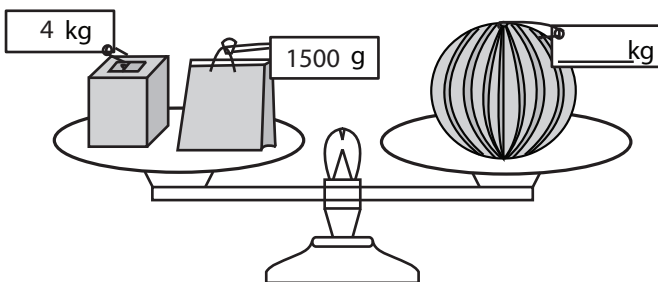

6)

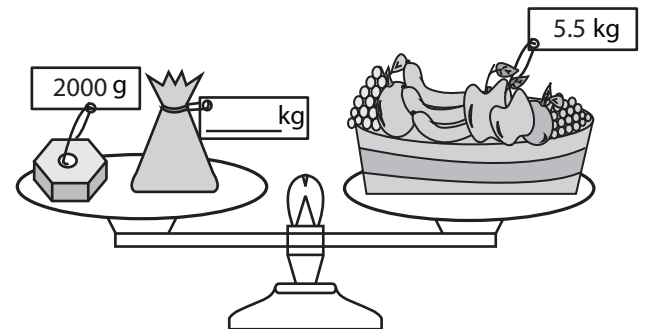

7)

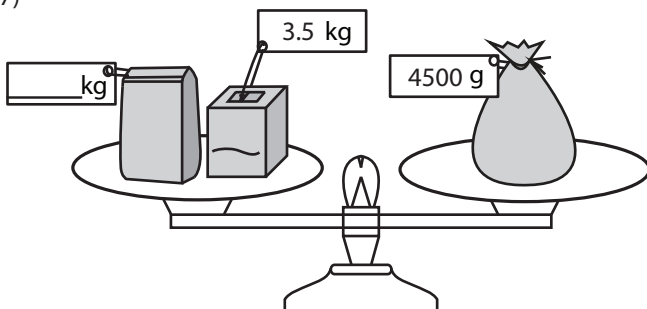

8)

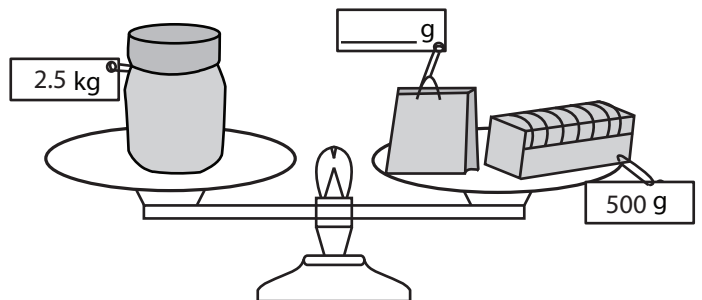

Name : _____

Score : _____

Answer key

Balancing Scale - Metric Units

MS2

Calculate the unknown weight to balance each scale.

1)

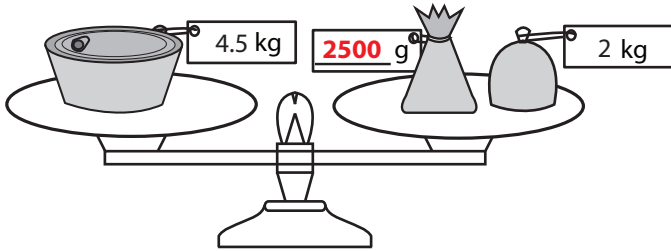

2)

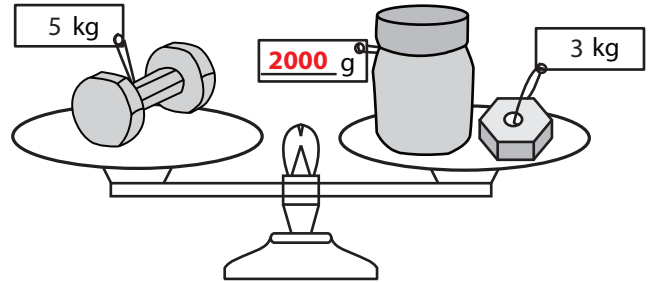

3)

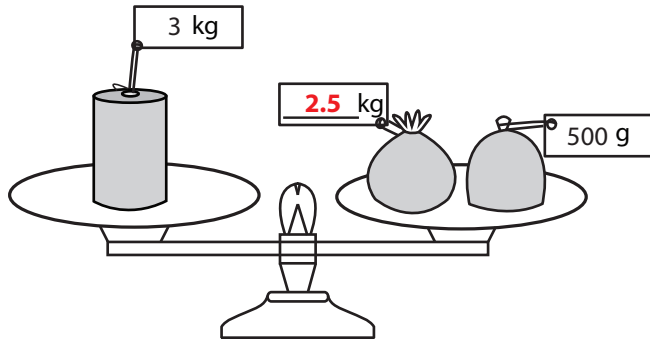

4)

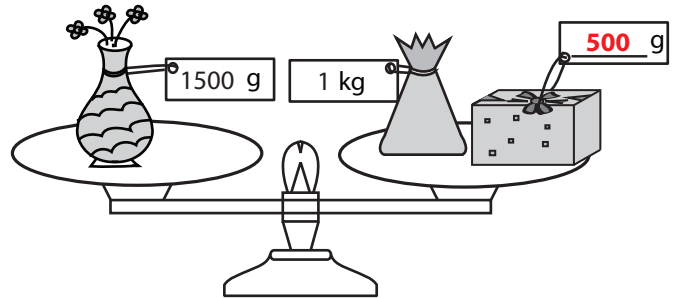

5)

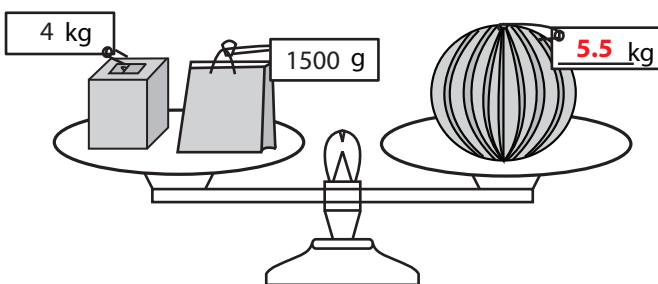

6)

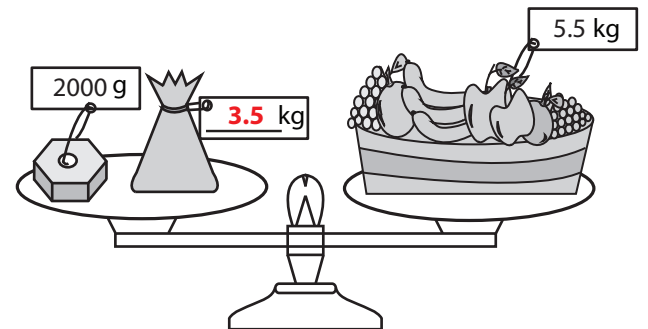

7)

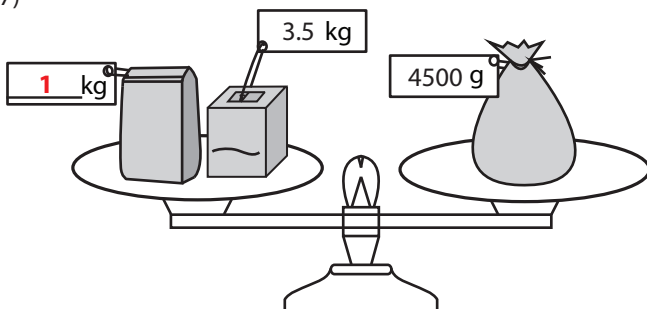

8)

