

Drawing Angles - 5° Increments

Draw each angle using a protractor.

1) 35°

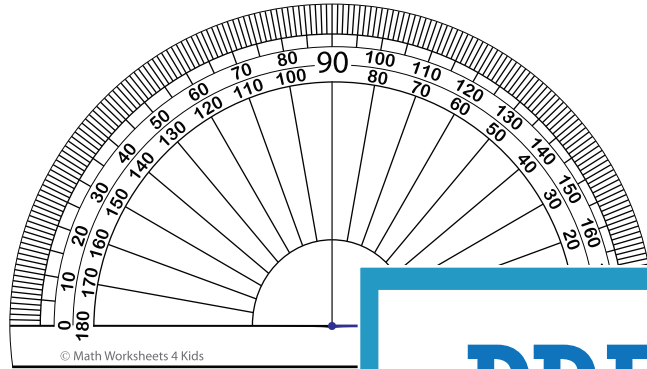

2) 145°

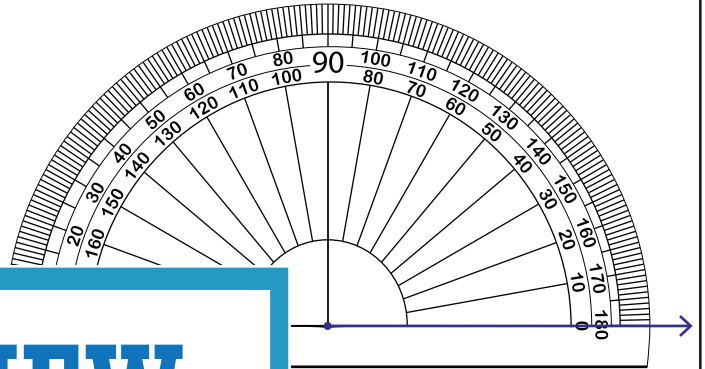

3) 100°

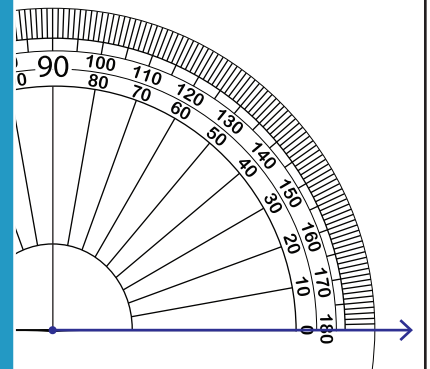
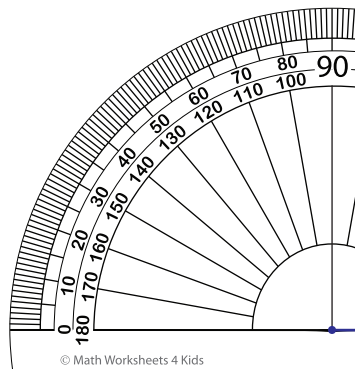

PREVIEW

Gain complete access to the largest collection of worksheets in all subjects!

Members, please log in to download this worksheet.

Not a member? Please sign up to gain complete access.

www.mathworksheets4kids.com

5) 50°

