

Name : _____

Reading a Protractor

Inner & outer scales: S5

Read the protractor and measure each angle.

1)

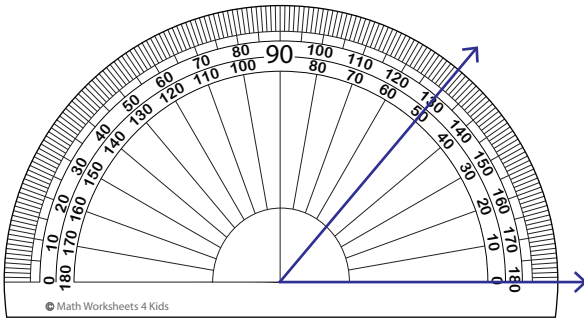

Angle: _____

2)

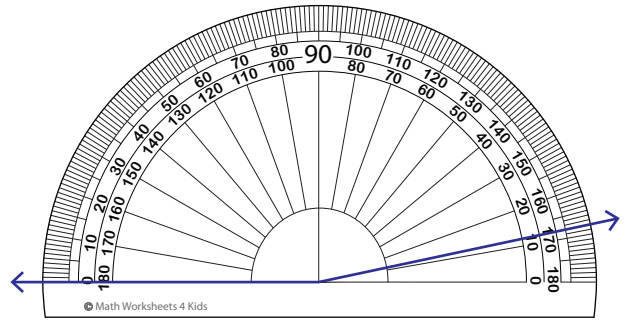

Angle: _____

3)

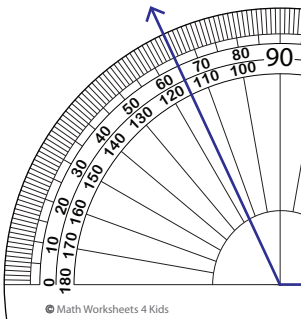

Angle: _____

PREVIEW

Gain complete access to the largest collection of worksheets in all subjects!

Members, please log in to download this worksheet.

Not a member? Please sign up to gain complete access.

www.mathworksheets4kids.com

5)

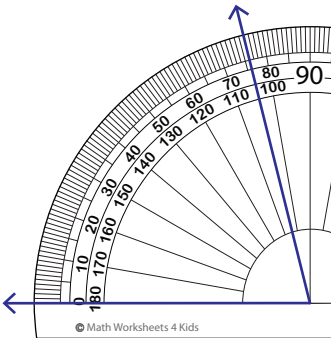

Angle: _____

7)

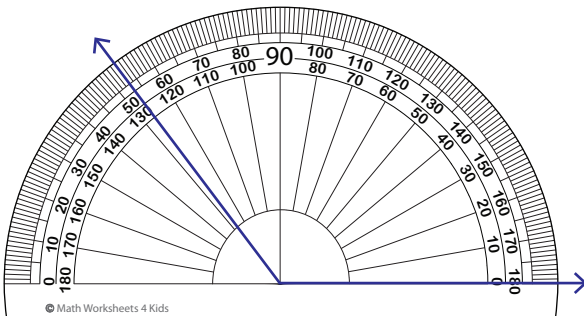

Angle: _____

8)

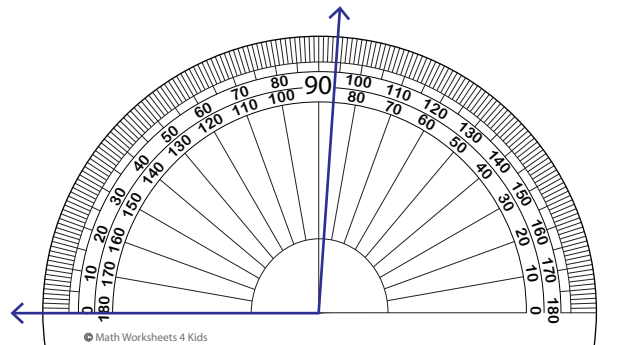

Angle: _____

Name : _____

Reading a Protractor

Inner & outer scales: S5

Read the protractor and measure each angle.

1)

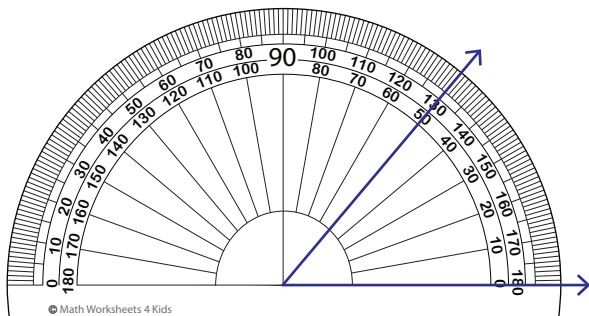

Angle: 50°

2)

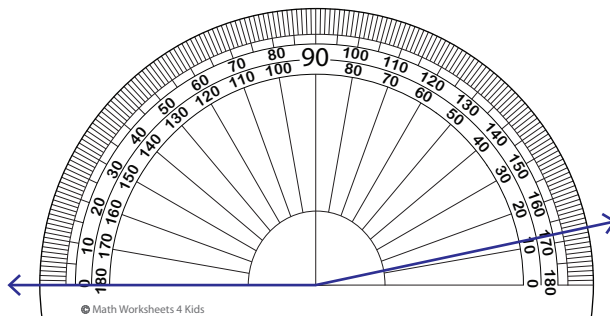

Angle: 168°

3)

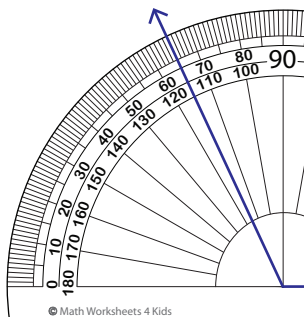

Angle: _____

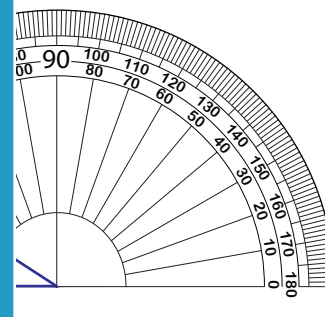

Angle: 33°

5)

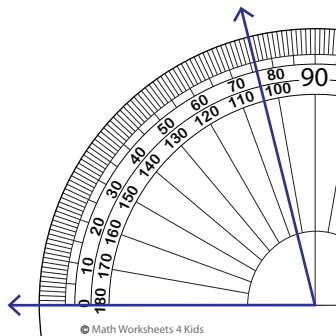

Angle: _____

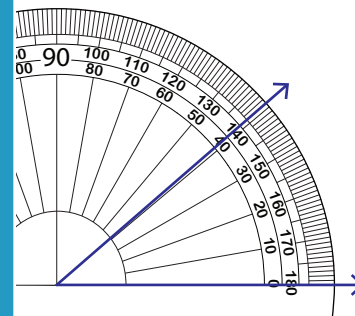

Angle: 41°

7)

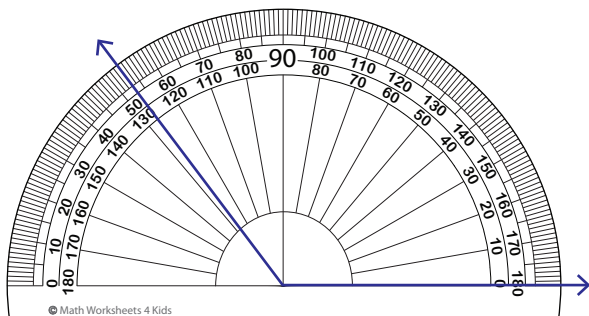

Angle: 127°

8)

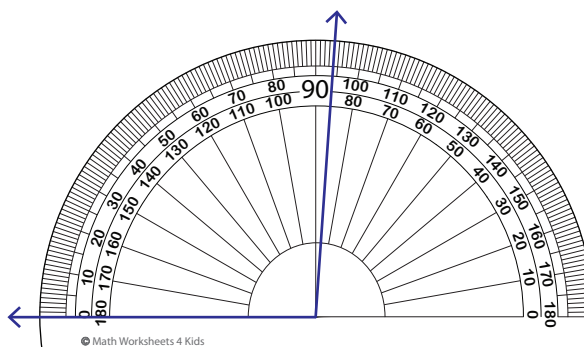

Angle: 94°

PREVIEW

Gain complete access to the largest collection of worksheets in all subjects!

Members, please log in to download this worksheet.

Not a member? Please sign up to gain complete access.

www.mathworksheets4kids.com