

Name : _____

Area - Shapes

Find the area of each shape.

1)

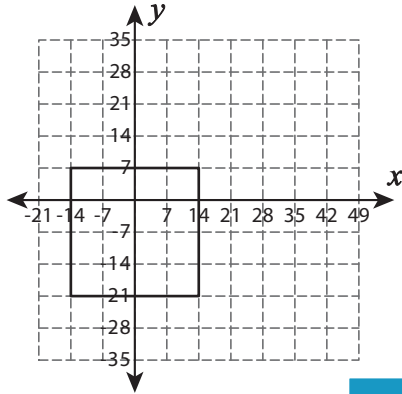

Area = _____

2)

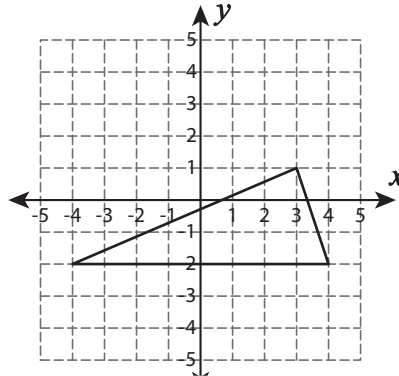

3)

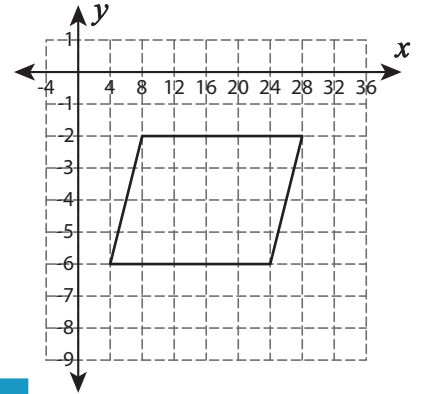

Area = _____

4)

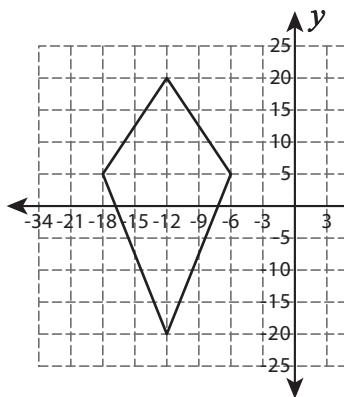

Area = _____

PREVIEW

Gain complete access to the largest collection of worksheets in all subjects!

Members, please log in to download this worksheet.

Not a member? Please sign up to gain complete access.

www.mathworksheets4kids.com

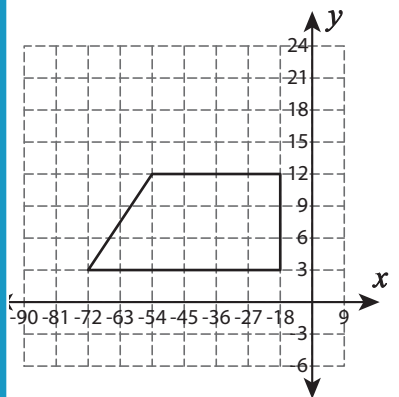

Area = _____

7)

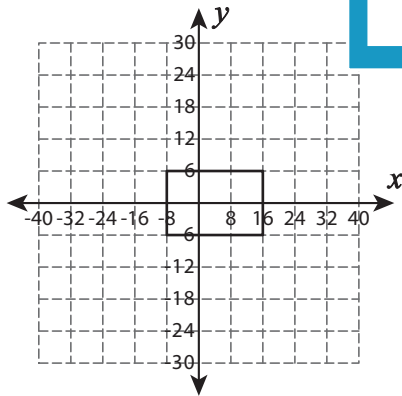

Area = _____

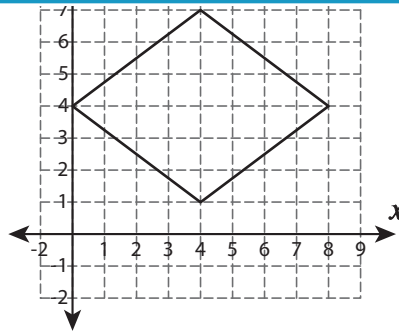

Area = _____

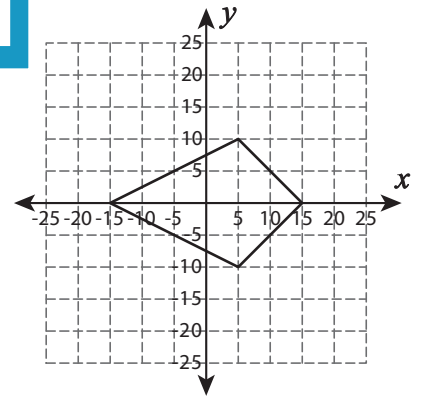

Area = _____

Name : _____

Answer key

Area - Shapes

Sheet 3

Find the area of each shape.

1)

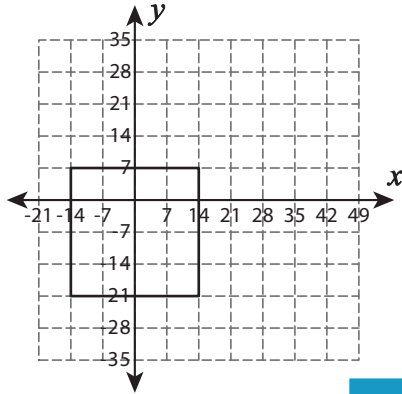

Area = 784 square units

2)

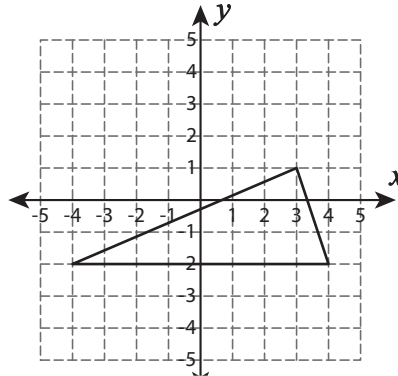

3)

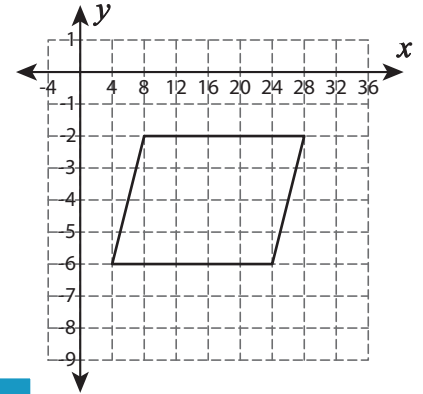

Area = 80 square units

4)

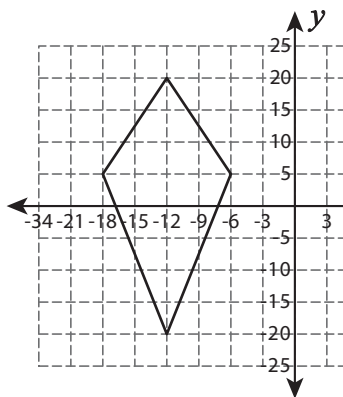

Area = 240 square units

PREVIEW

Gain complete access to the largest collection of worksheets in all subjects!

Members, please log in to download this worksheet.

Not a member? Please sign up to gain complete access.

www.mathworksheets4kids.com

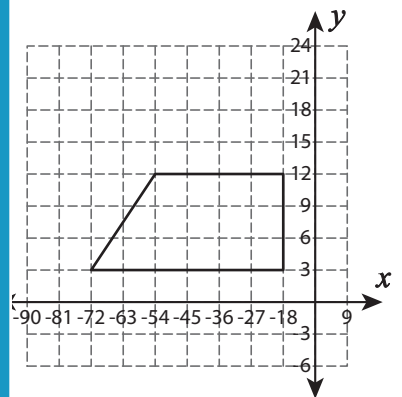

Area = 405 square units

7)

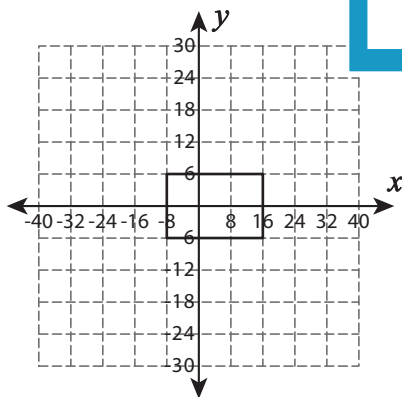

Area = 288 square units

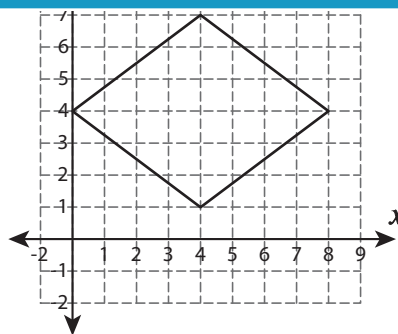

Area = 24 square units

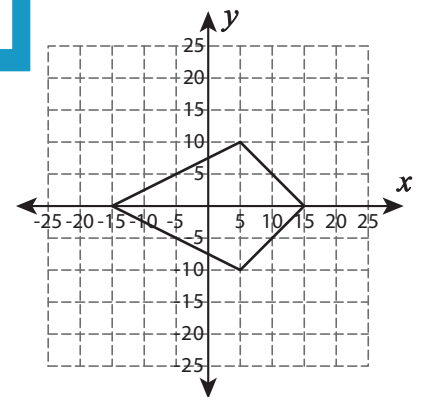

Area = 300 square units