



Name : \_\_\_\_\_

# NUMBER NAMES

A) Read each number name and circle the appropriate number of items.

Three	
Six	
Two	

B) Read aloud and color the appropriate number of items.

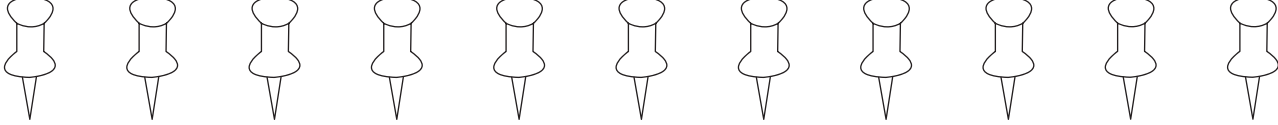
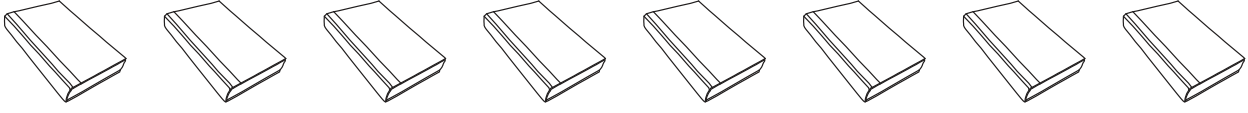
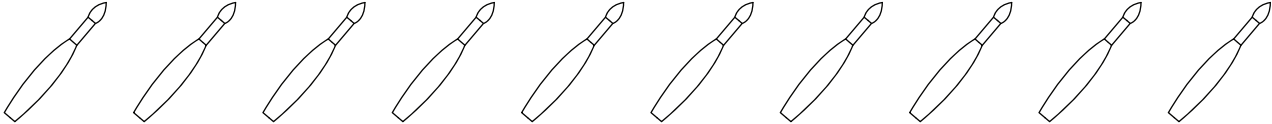
Nine	
Four	
Seven	

C) Write in numerals.

1) Four \_\_\_\_\_

2) Ten \_\_\_\_\_

3) Eight \_\_\_\_\_

4) Five \_\_\_\_\_

D) Match the number names with the numerals.

1) Three

1

2) Eight

9

3) One

3

4) Nine

8

Name : \_\_\_\_\_

# Count & Compare

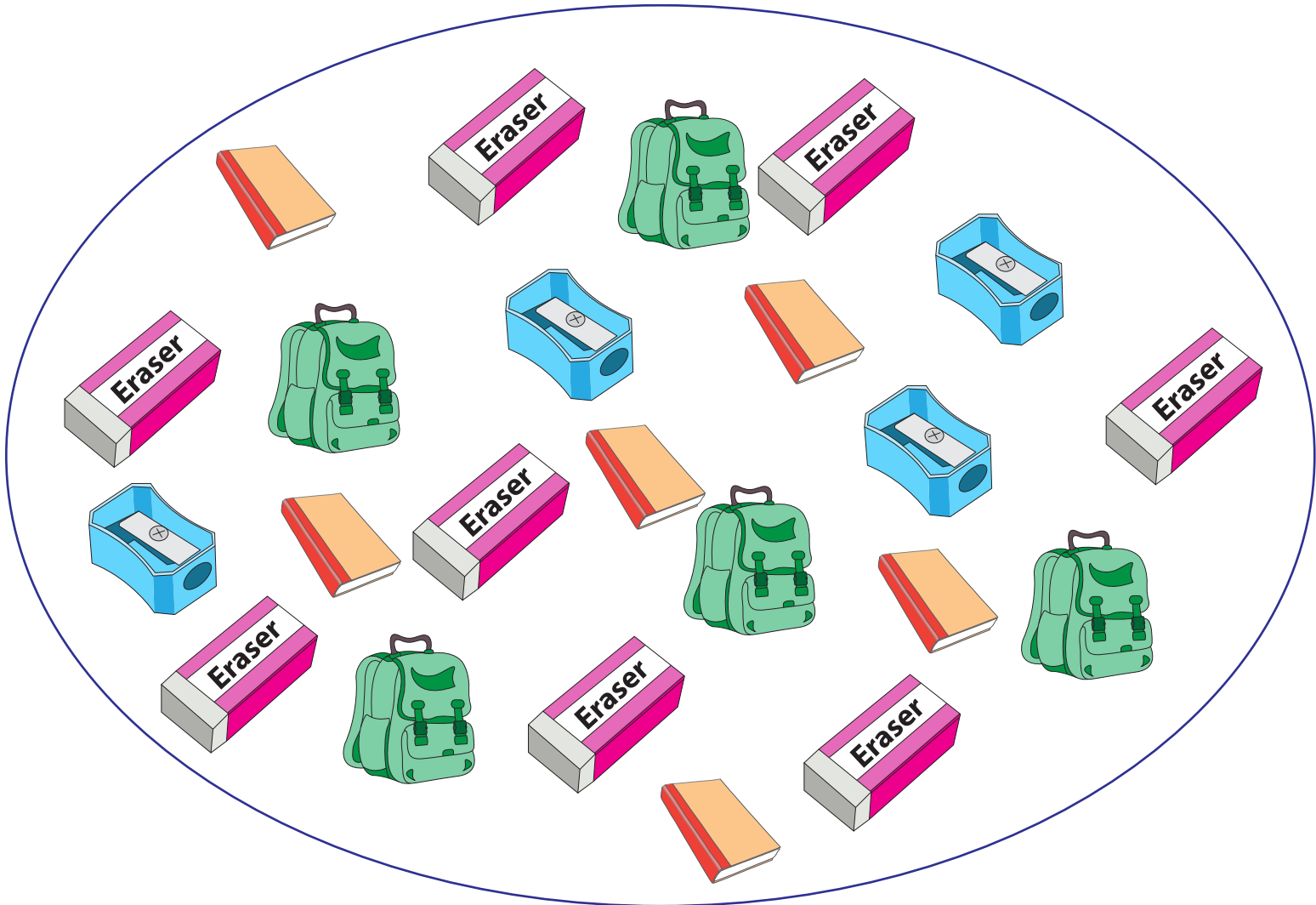

How many  ? \_\_\_\_\_

How many  ? \_\_\_\_\_

How many  ? \_\_\_\_\_

How many  ? \_\_\_\_\_

Which is the most?



Which is the fewest?



How many more  than  ? \_\_\_\_\_

How many fewer  than  ? \_\_\_\_\_

Name: \_\_\_\_\_

## Count: Add/Subtract

1)

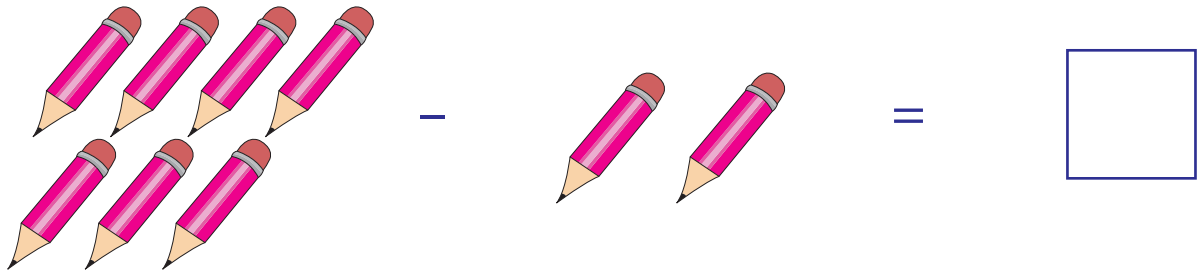

2)

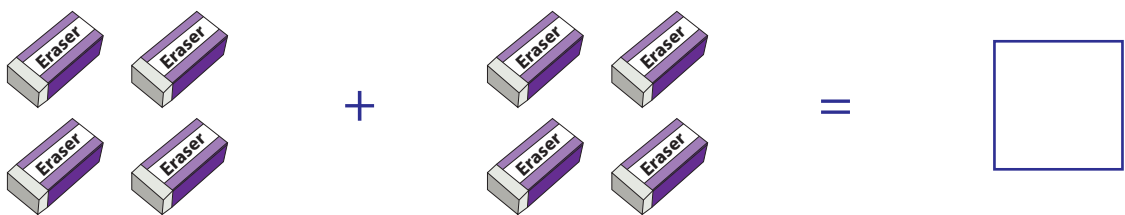

3)

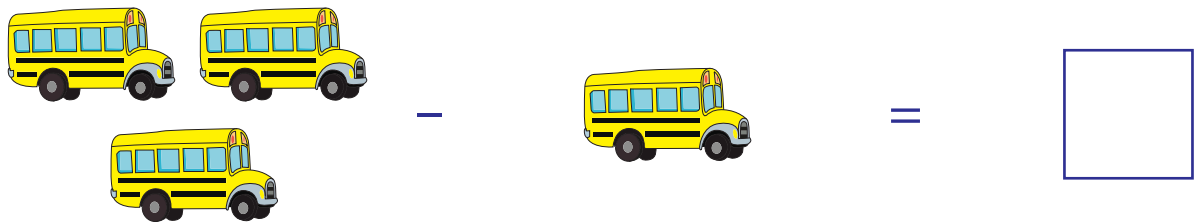

4)

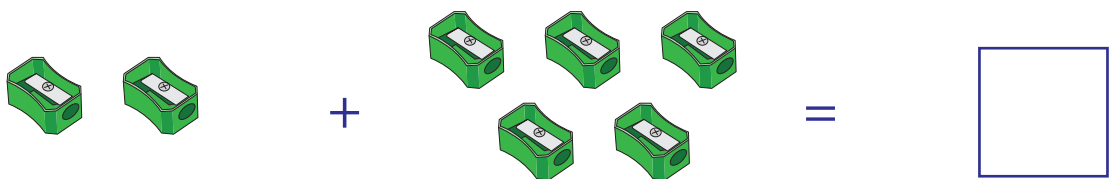

5)

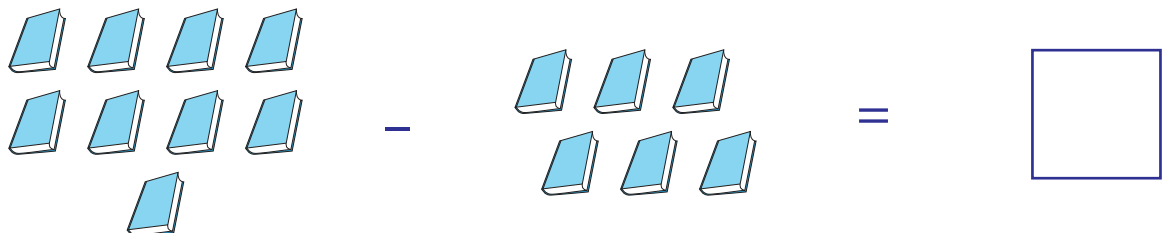

Name : \_\_\_\_\_

# SHAPES

A) Trace and color each shape.

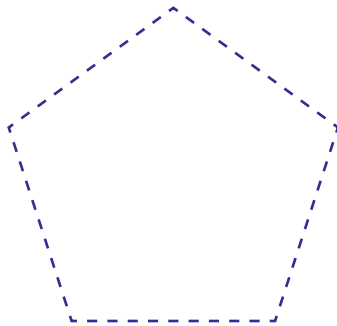
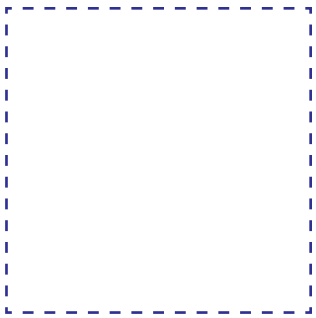
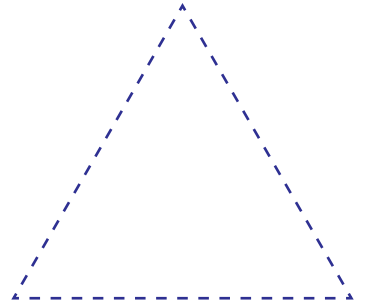
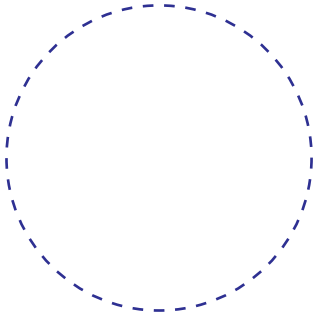

B) Match the shapes to the real-life objects.

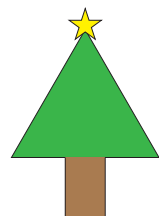
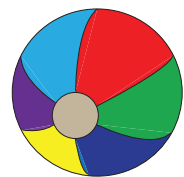
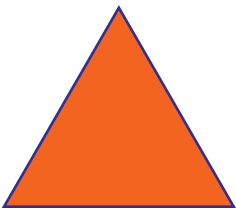
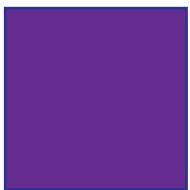
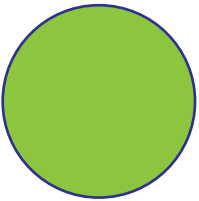





Name : \_\_\_\_\_

## Answer key

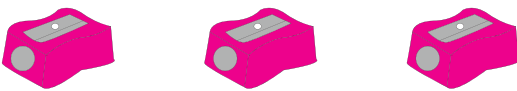
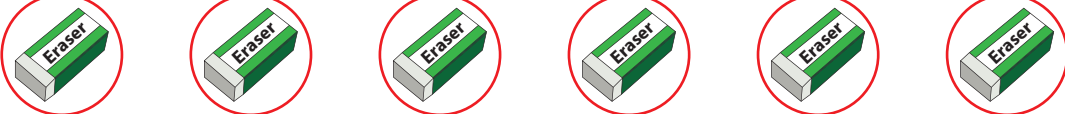
# NUMBER NAMES

A) Read each number name and circle the appropriate number of items.

Three		
Six		
Two		

B) Read aloud and color the appropriate number of items.

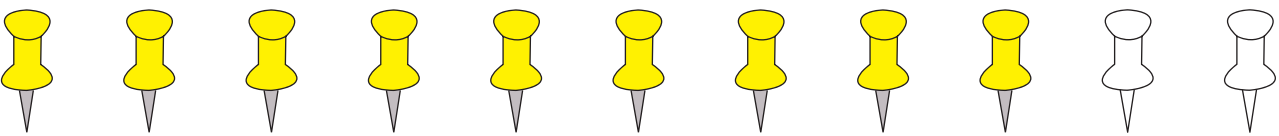
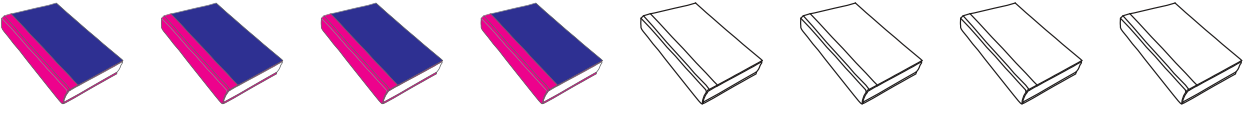
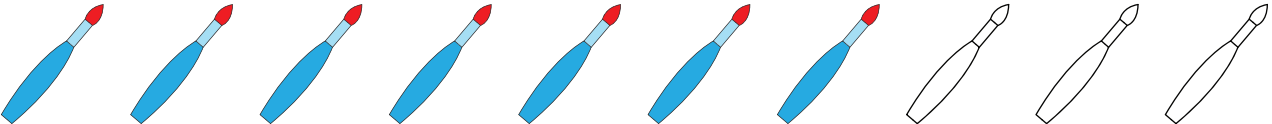
Nine	
Four	
Seven	

C) Write in numerals.





1) Four 4

2) Ten 10

3) Eight 8

4) Five 5

D) Match the number names with the numerals.

- 1) Three 
- 2) Eight 
- 3) One 
- 4) Nine 

Name : \_\_\_\_\_

Answer key

# Count & Compare

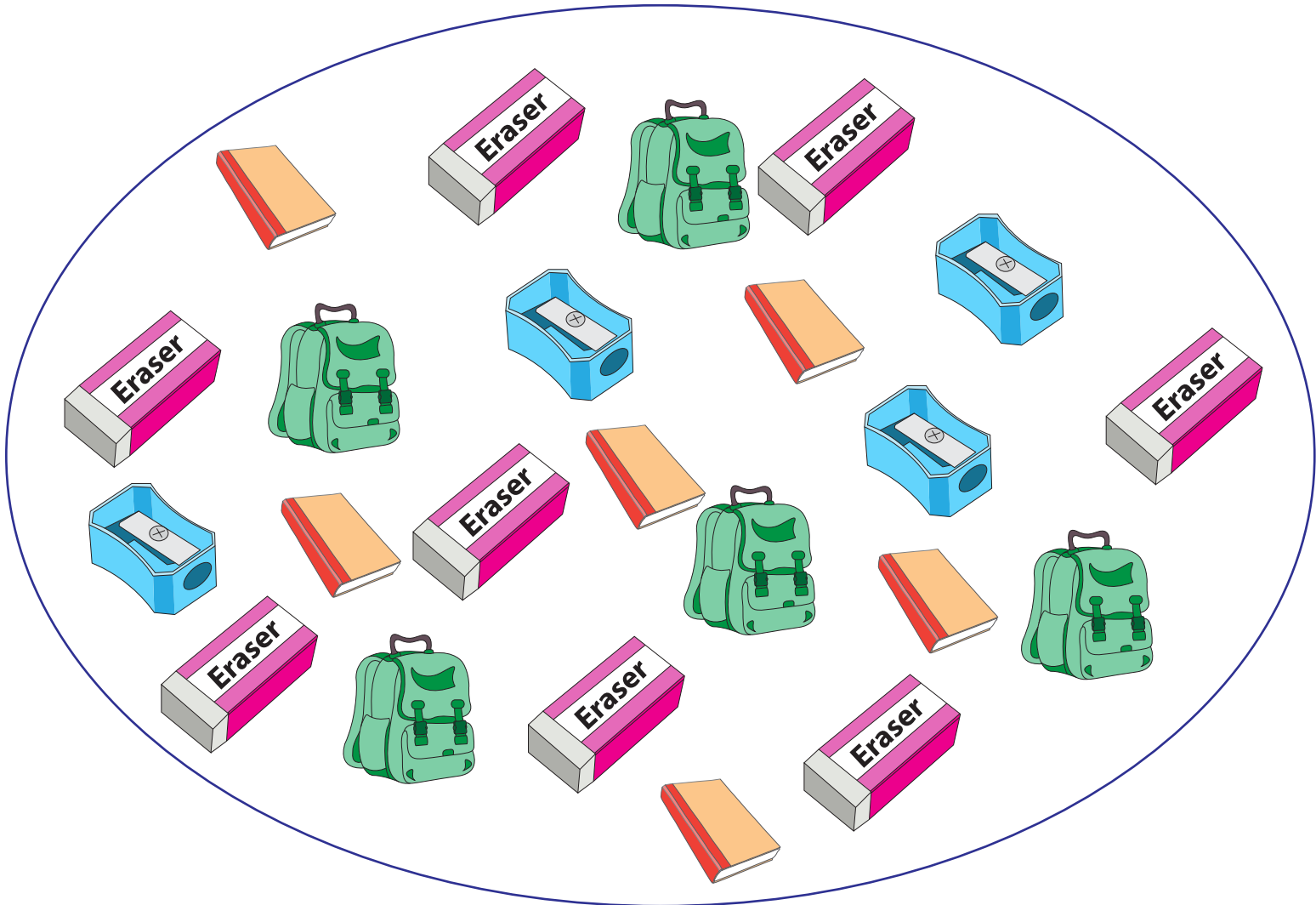

How many  ? 6

How many  ? 4

How many  ? 8

How many  ? 5

Which is the most?



Which is the fewest?



How many more  than  ? 2

How many fewer  than  ? 3

Name: \_\_\_\_\_

## Answer key

### Count: Add/Subtract

1)

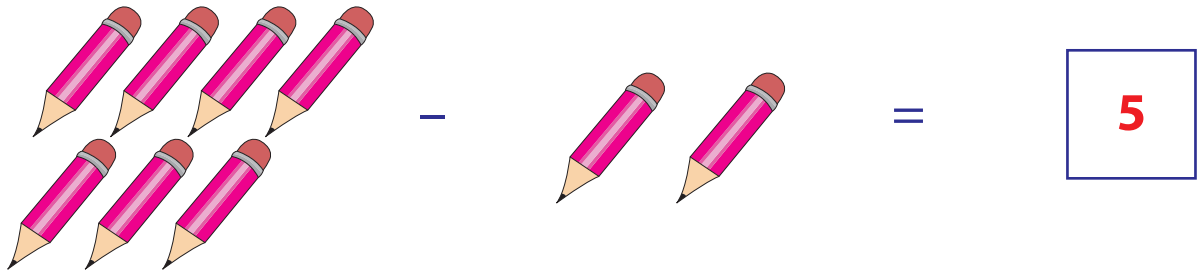

2)

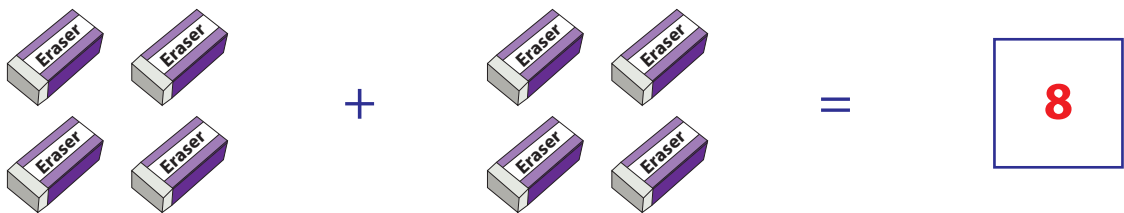

3)

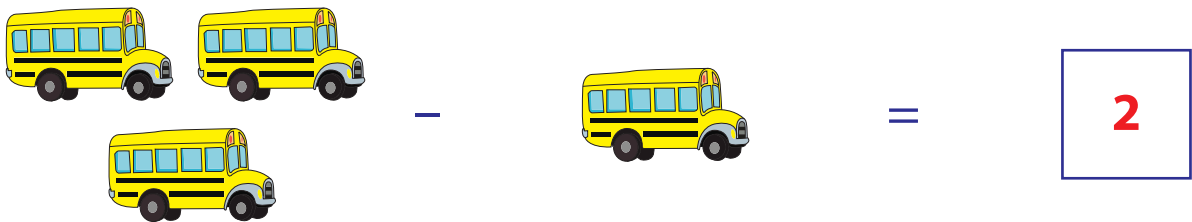

4)

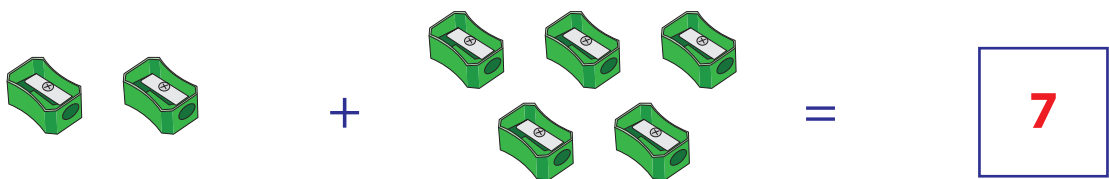

5)

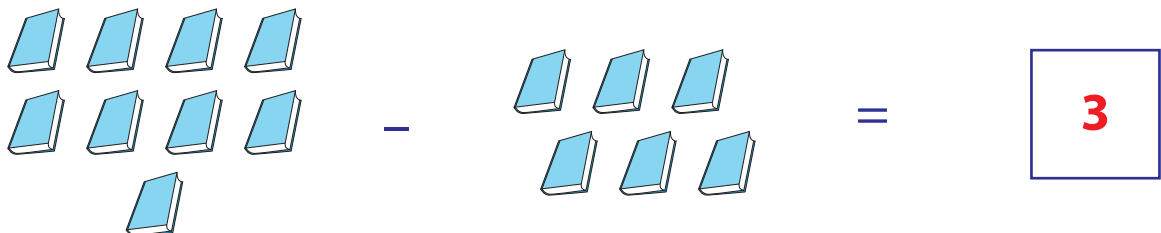

Name : \_\_\_\_\_

## Answer key

# SHAPES

A) Trace and color each shape.

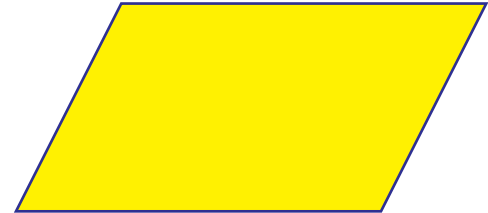
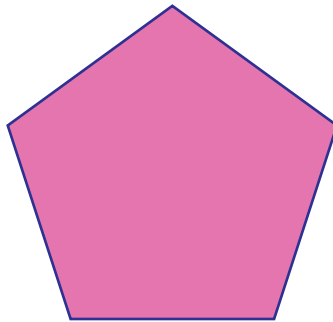
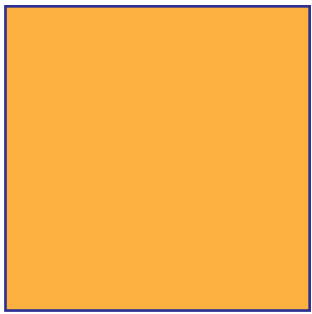
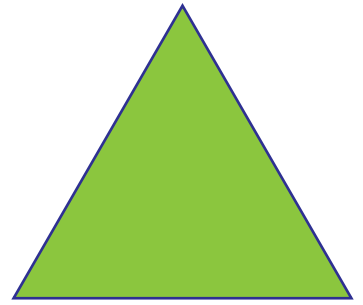
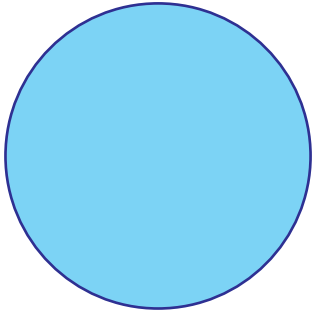

B) Match the shapes to the real-life objects.

