

Place Value Blocks - 2 Digits

L2S5

Write the number formed by base ten blocks.

1)

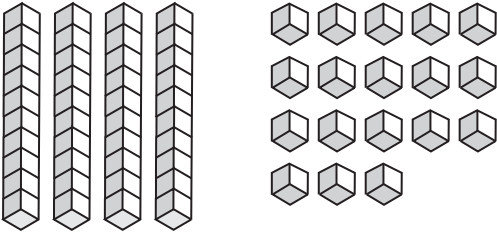

2)

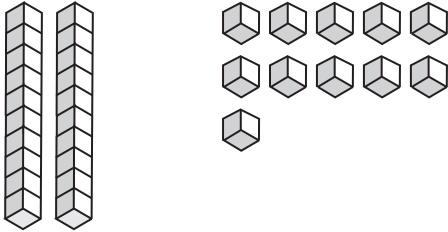

3)

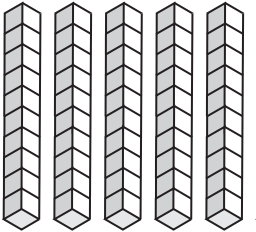

PREVIEW

Gain complete access to the largest
collection of worksheets in all subjects!

Members, please
log in to
download this
worksheet.

Not a member?
Please sign up to
gain complete
access.

www.mathworksheets4kids.com

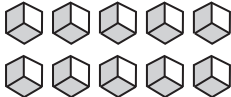

5)

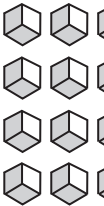
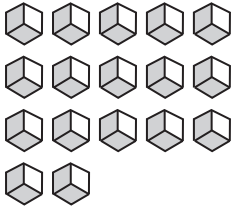
7)

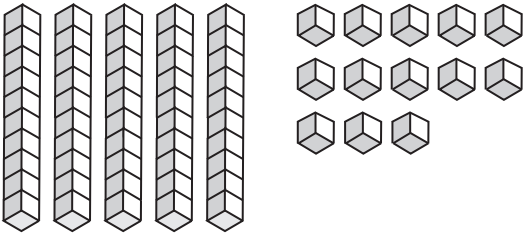

8)

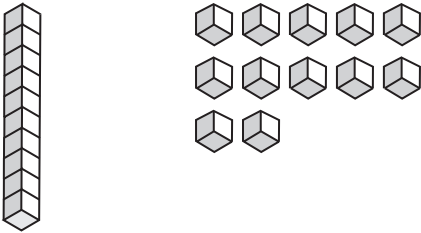

Answer key**Place Value Blocks - 2 Digits**

L2S5

Write the number formed by base ten blocks.

1)

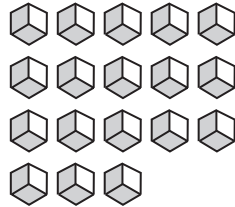
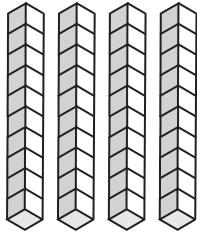
**58**

2)

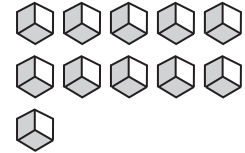
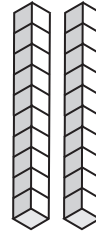
**31**

3)

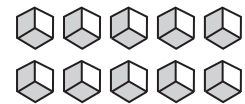
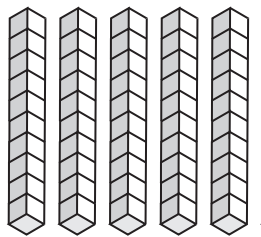
**40**

5)

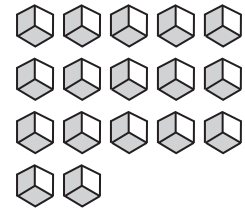
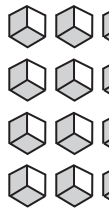
**67**

7)

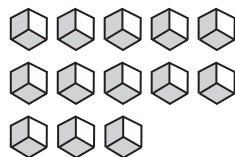
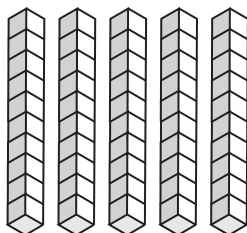
**63**

8)

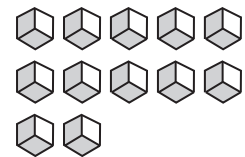
**22****PREVIEW**

Gain complete access to the largest
collection of worksheets in all subjects!

Members, please
log in to
download this
worksheet.

Not a member?
Please sign up to
gain complete
access.

www.mathworksheets4kids.com