





Name : _____

Subtraction Sentence - Thousandths

No regrouping: S4

Ones	Tenths	Hundredths	Thousandths
			

1)

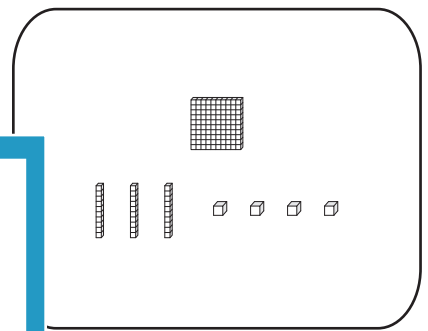
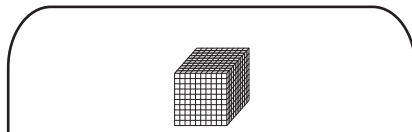
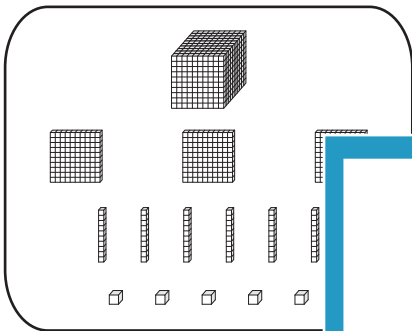

PREVIEW

Gain complete access to the largest collection of worksheets in all subjects!

Members, please log in to download this worksheet.

Not a member? Please sign up to gain complete access.

www.mathworksheets4kids.com

2)

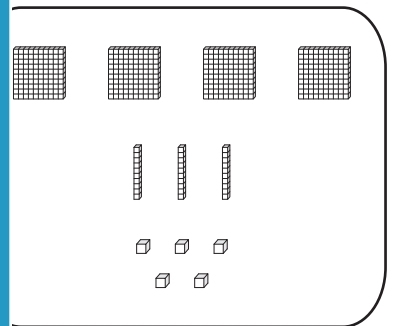
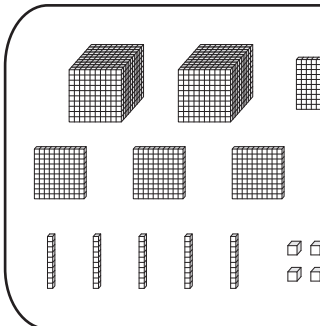

3)

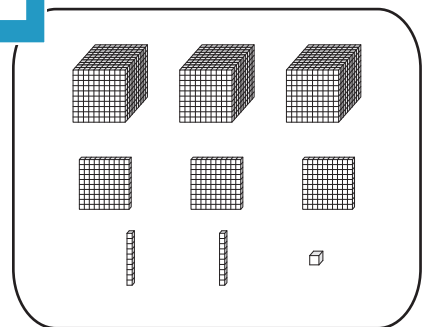
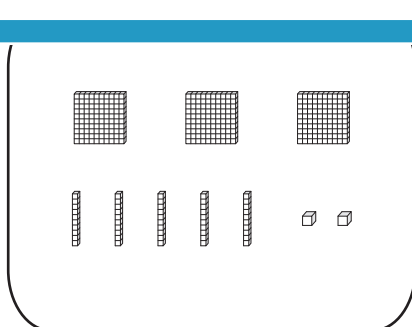
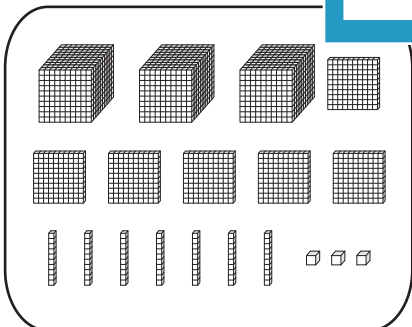





Name : _____

Answer key

Subtraction Sentence - Thousandths

No regrouping: S4

Ones	Tenths	Hundredths	Thousandths
			

1)

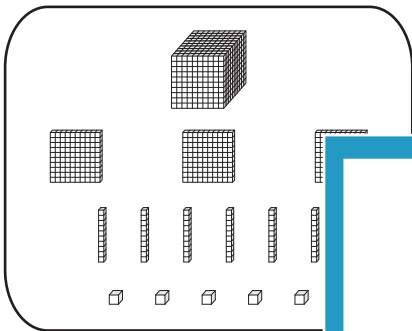

1.365

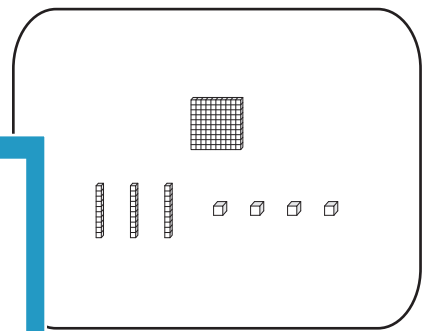
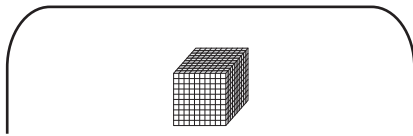

0.134

PREVIEW

Gain complete access to the largest collection of worksheets in all subjects!

Members, please log in to download this worksheet.

Not a member? Please sign up to gain complete access.

www.mathworksheets4kids.com

2)

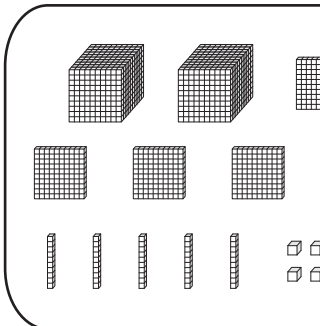

2.558

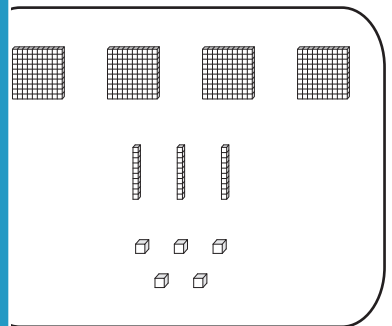

0.435

3)

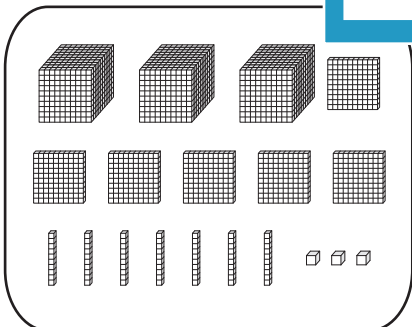

3.673

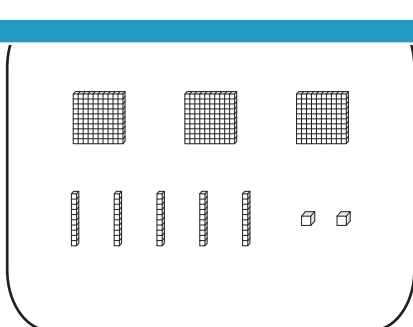

0.352

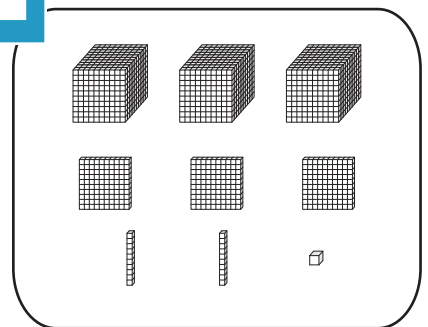

3.321