

Perimeter

MS2

Calculate the perimeter of each shape.

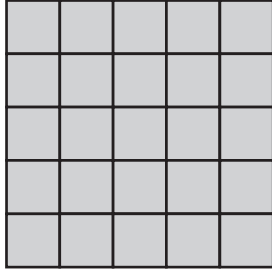
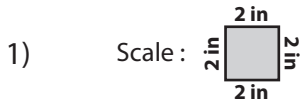

Perimeter = _____

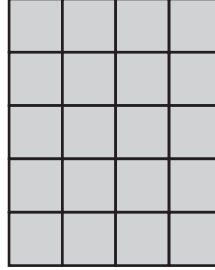

Perimeter = _____

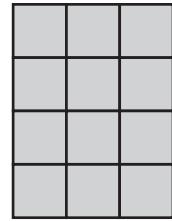

Perimeter = _____

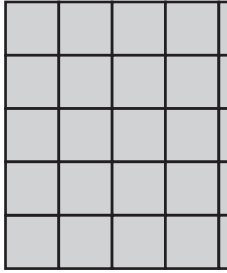
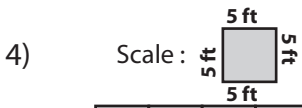

Perimeter = _____

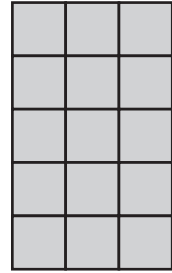
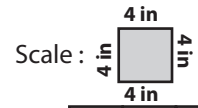

Perimeter = _____

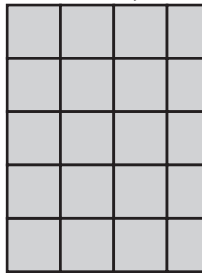

Perimeter = _____

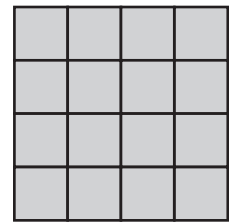
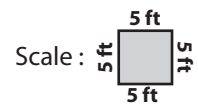

Perimeter = _____



Perimeter = _____

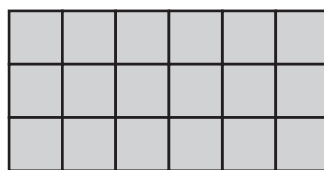

Perimeter = _____

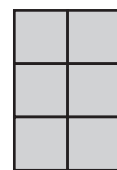

Perimeter = _____

PREVIEW

Access the largest collection of
worksheets for just **\$19.95** per year!

Members, please
log in to
download this
worksheet.

Log in

Not a member?
Please sign up to
gain complete
access.

Sign up

www.mathworksheets4kids.com

Perimeter

MS2

Calculate the perimeter of each shape.

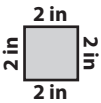
1) Scale :  Perimeter = 40 in

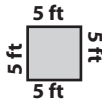
2) Scale :  Perimeter = 90 ft

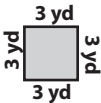
3) Scale :  Perimeter = 42 yd

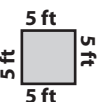
4) Scale :  Perimeter = 11

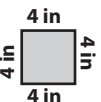
Scale :  Perimeter = 64 in

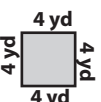
7) Scale :  Perimeter = 80

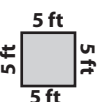
Scale :  Perimeter = 80 ft

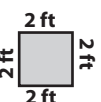
10) Scale :  Perimeter = 24 ft

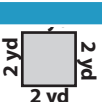
11) Scale :  Perimeter = 36 yd

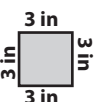
12) Scale :  Perimeter = 30 in

PREVIEW

Access the largest collection of worksheets for just **\$19.95** per year!

Members, please log in to download this worksheet.

Log in

Not a member? Please sign up to gain complete access.

Sign up

www.mathworksheets4kids.com