

Name : _____

Area of a Quadrilateral

Sheet 3

Find the area of each shape.

1)

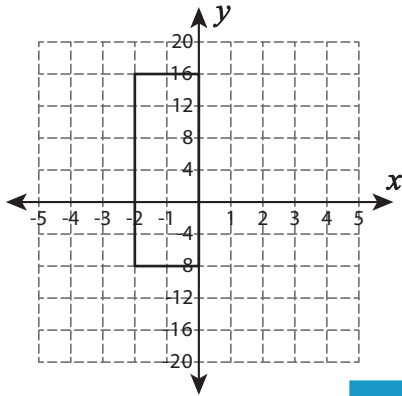

Area = _____

2)

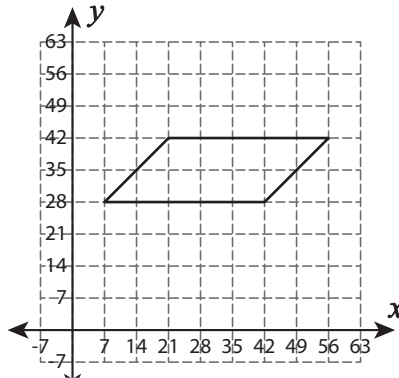

3)

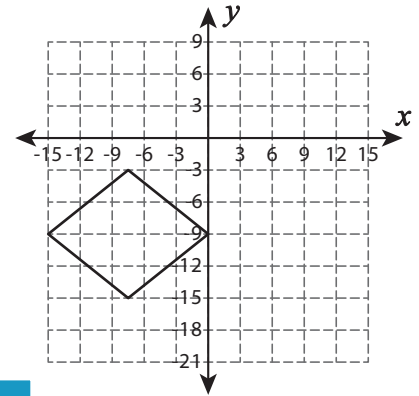

Area = _____

4)

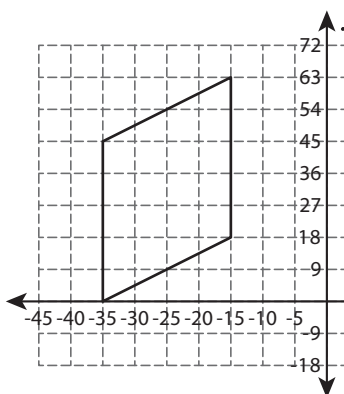

Area = _____

PREVIEW

Gain complete access to the largest collection of worksheets in all subjects!

Members, please log in to download this worksheet.

Not a member? Please sign up to gain complete access.

www.mathworksheets4kids.com

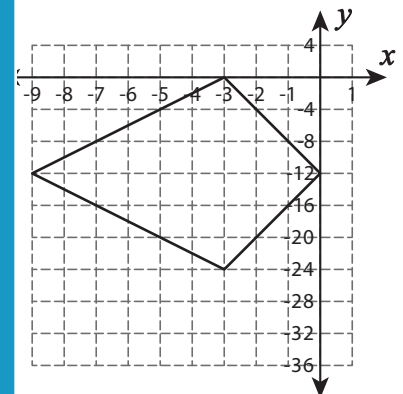

Area = _____

7)

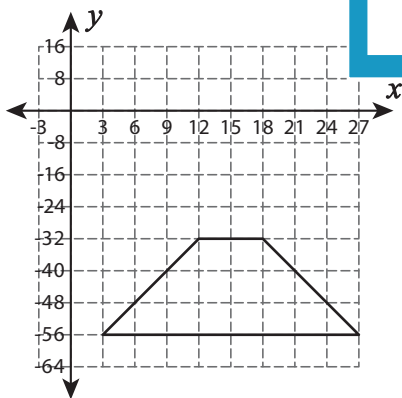

Area = _____

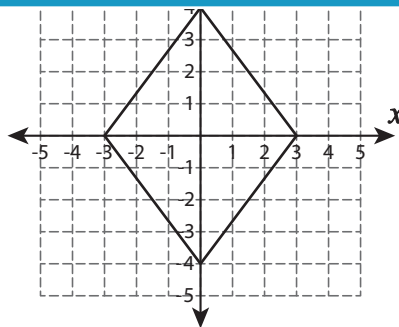

Area = _____

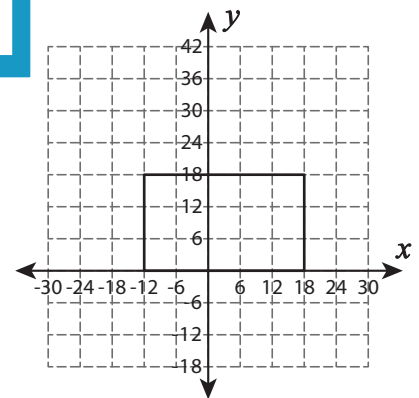

Area = _____

Name : _____

Answer key

Sheet 3

Area of a Quadrilateral

Find the area of each shape.

1)

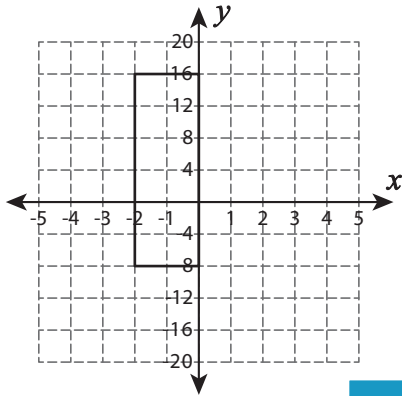

Area = 48 sq.units

2)

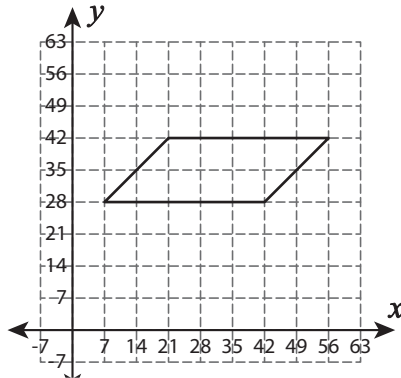

3)

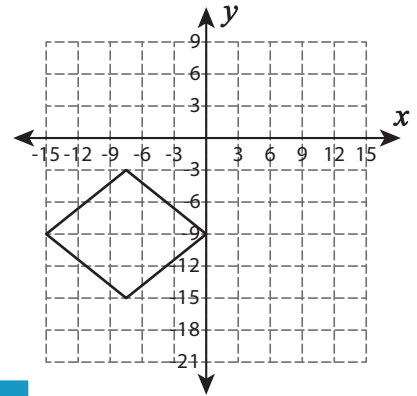

Area = 90 sq.units

4)

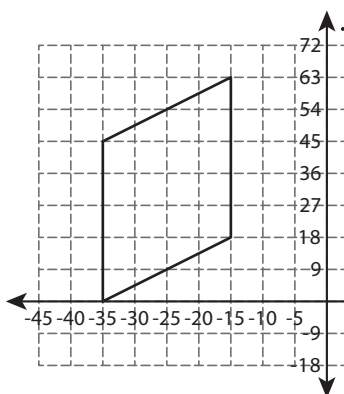

Area = 900 sq.units

PREVIEW

Gain complete access to the largest collection of worksheets in all subjects!

Members, please log in to download this worksheet.

Not a member? Please sign up to gain complete access.

www.mathworksheets4kids.com

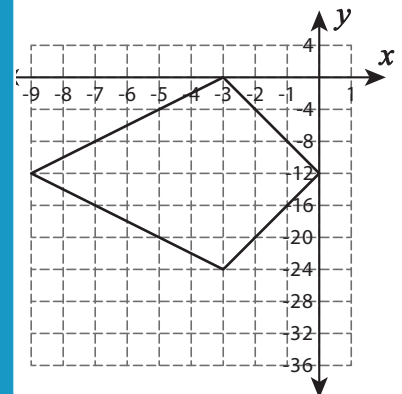

Area = 108 sq.units

7)

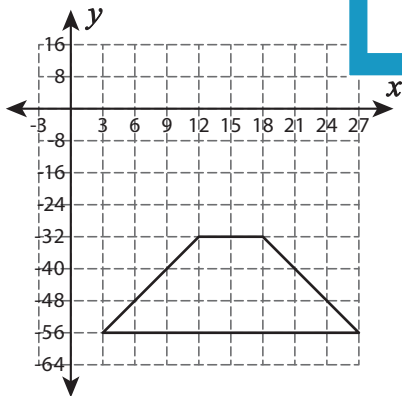

Area = 360 sq.units

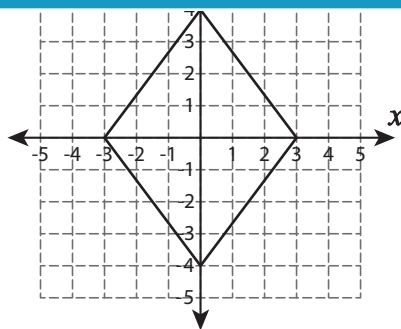

Area = 24 sq.units

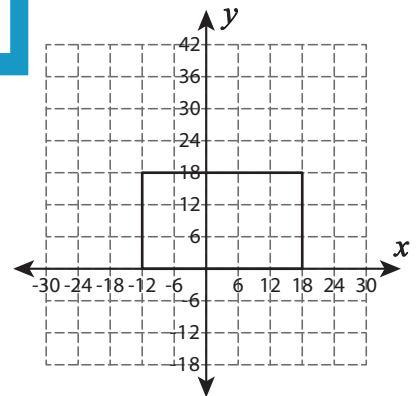

Area = 540 sq.units