

Name : _____

Conductors vs Insulators

Cut out the pictures and glue them in the correct boxes.

Conductors

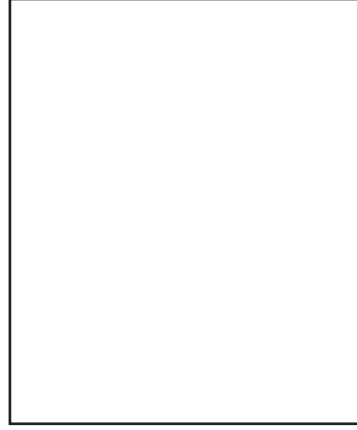
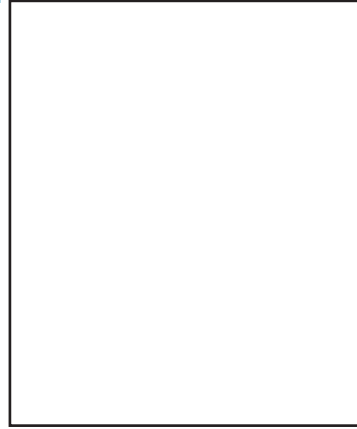
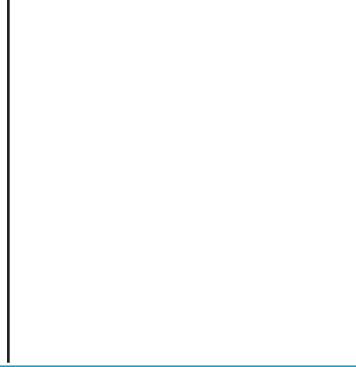
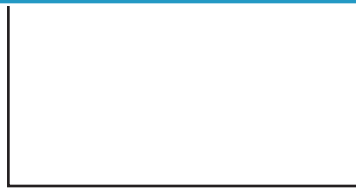
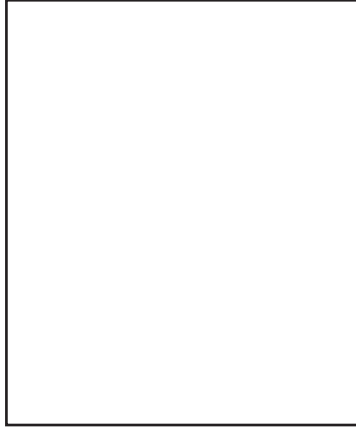
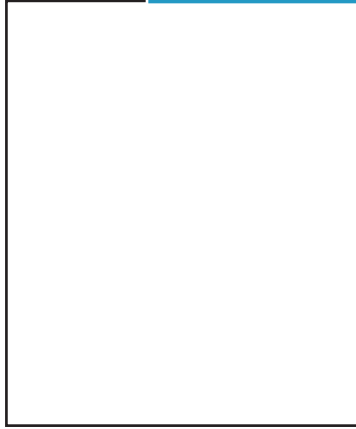

Insulators

PREVIEW

Access the largest collection of worksheets for just **\$19.95** per year!

Members, please log in to download this worksheet.

Not a member? Please sign up to gain complete access.

www.mathworksheets4kids.com

Log in **Sign up**

Name : _____

Conductors vs Insulators

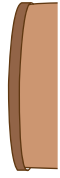
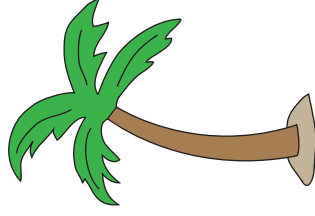
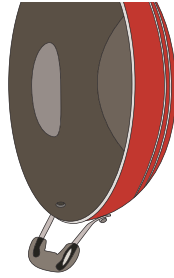
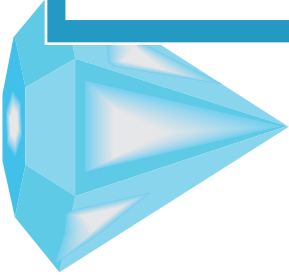

PREVIEW

Access the largest collection of worksheets for just **\$19.95** per year!

Members, please log in to download this worksheet.

Not a member? Please sign up to gain complete access.

www.mathworksheets4kids.com

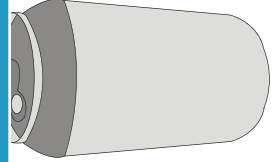
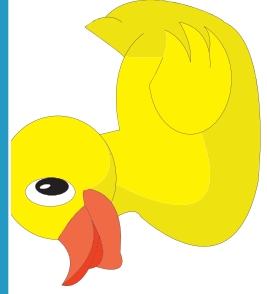

Name : _____

Answer key

Conductors vs Insulators

Cut out the pictures and glue them in the correct boxes.

Conductors

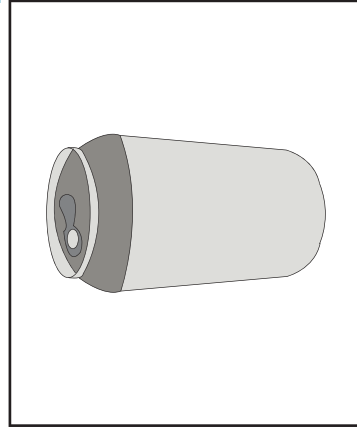
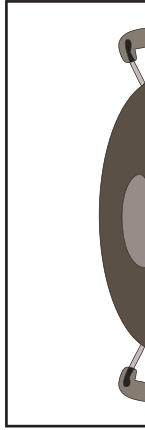
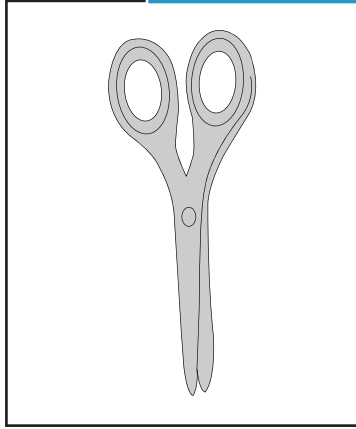

Insulators

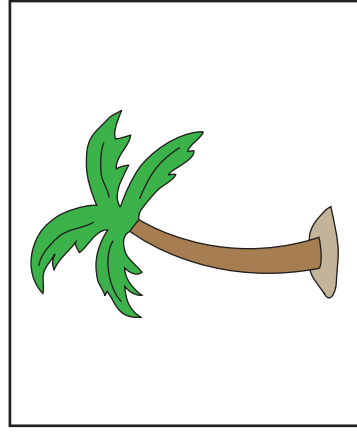
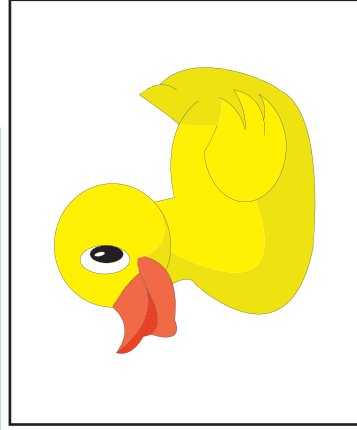
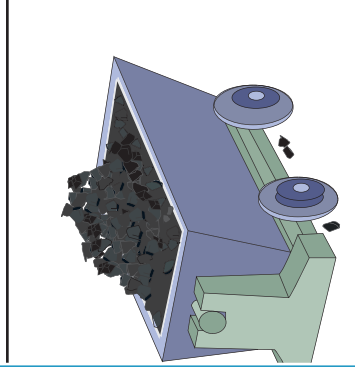
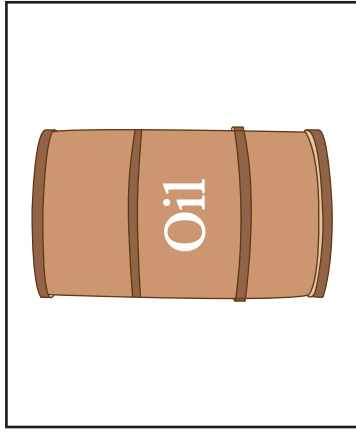

PREVIEW

Access the largest collection of worksheets for just **\$19.95** per year!

Members, please log in to download this worksheet.

Not a member? Please sign up to gain complete access.

www.mathworksheets4kids.com

