

Name : _____

Composing & Matching

Match each set of 3D shapes to the new shape that can be constructed using them.

1)

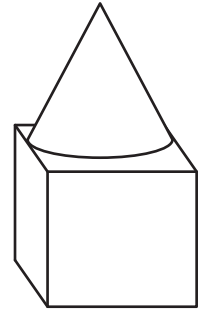
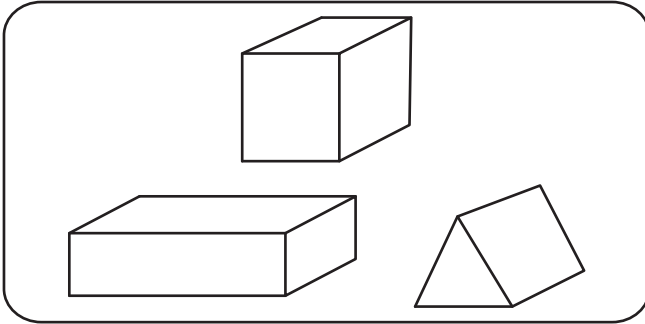

2)

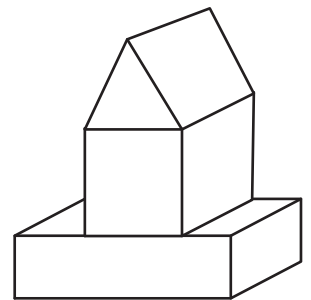
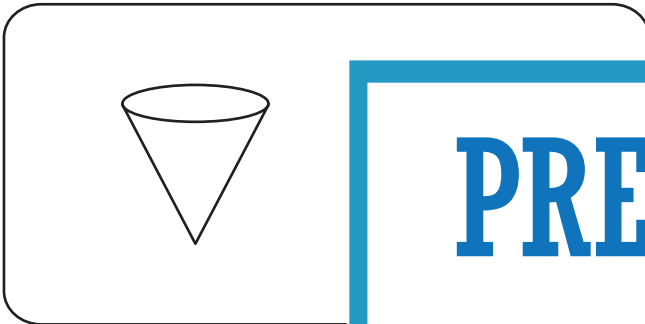

3)

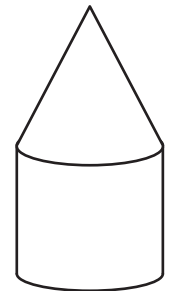
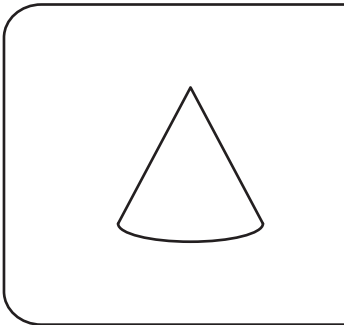

4)

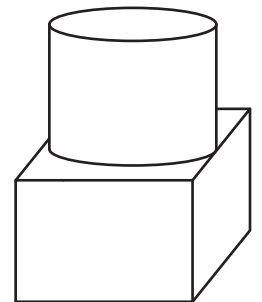
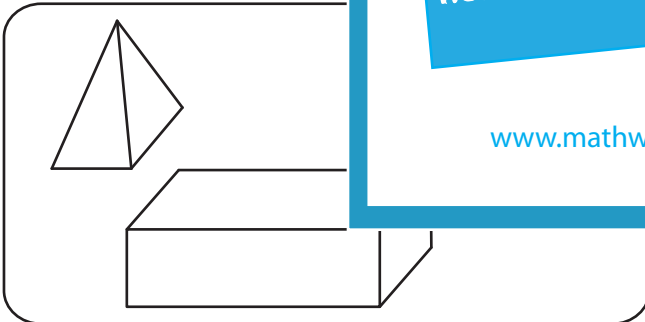

5)

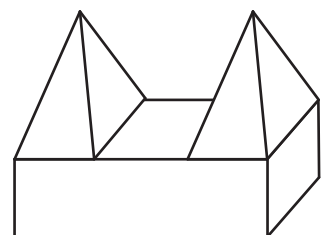
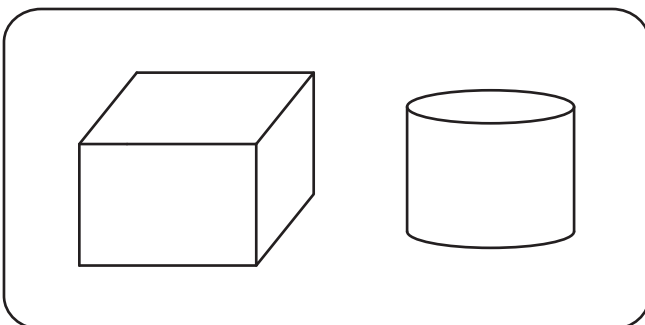

PREVIEW

Gain complete access to the largest collection of worksheets in all subjects!

Members, please log in to download this worksheet.

Not a member? Please sign up to gain complete access.

www.mathworksheets4kids.com

Name : _____

Composing & Matching

Match each set of 3D shapes to the new shape that can be constructed using them.

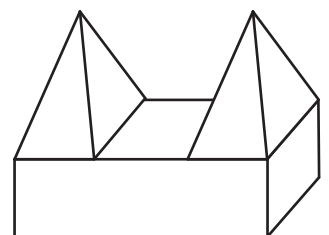
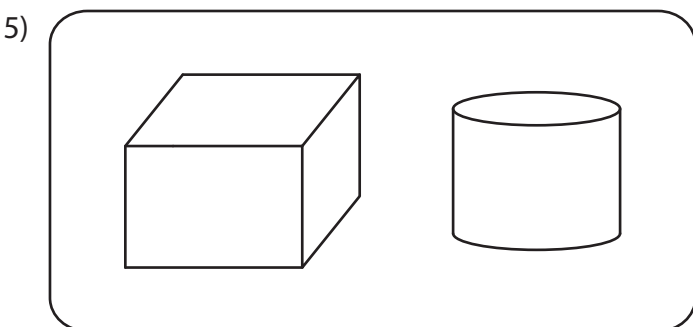
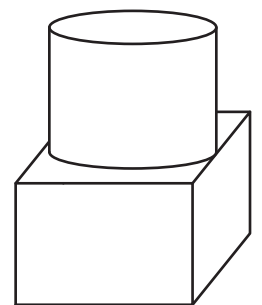
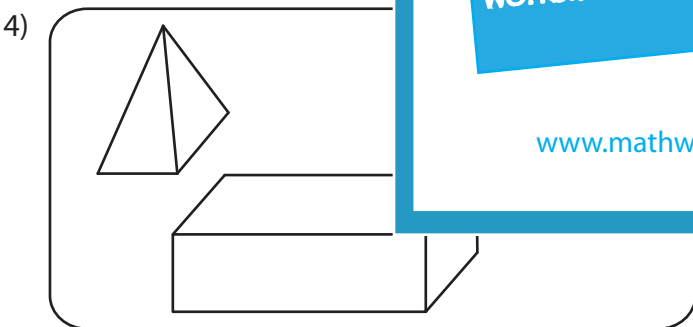
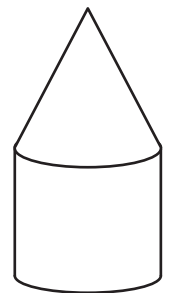
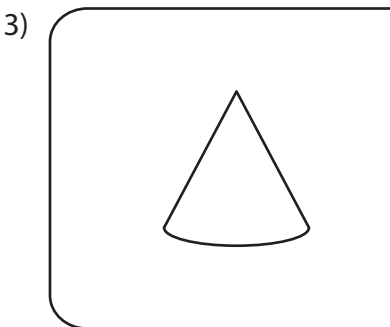
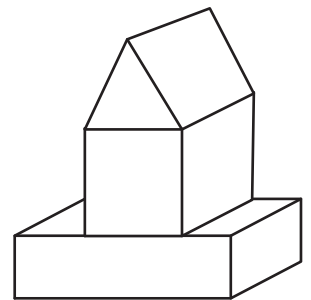
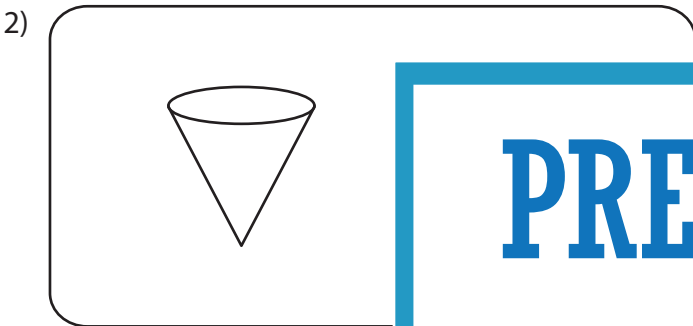
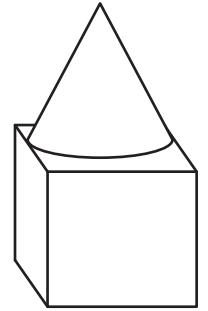
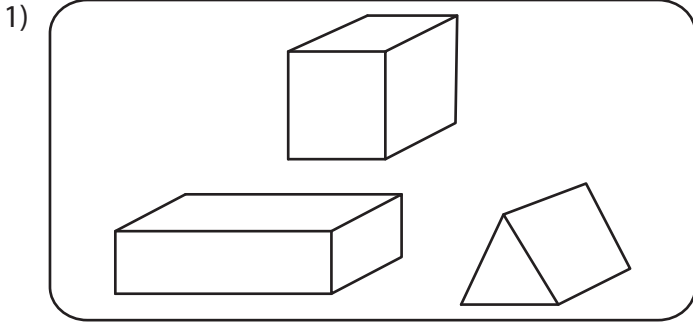

PREVIEW

Gain complete access to the largest collection of worksheets in all subjects!

Members, please log in to download this worksheet.

Not a member? Please sign up to gain complete access.

www.mathworksheets4kids.com

