

Mirror Images

Graph the image of the given figure across the mirror line.

1)

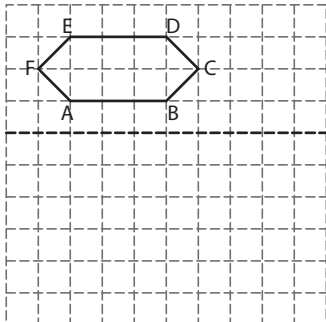

2)

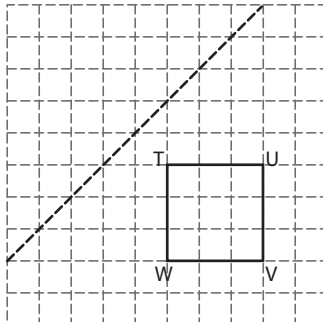

3)

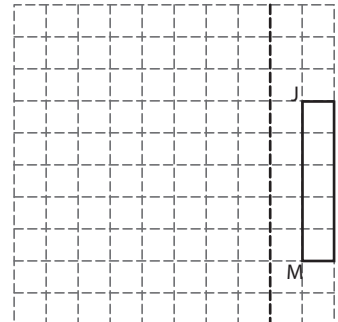

4)

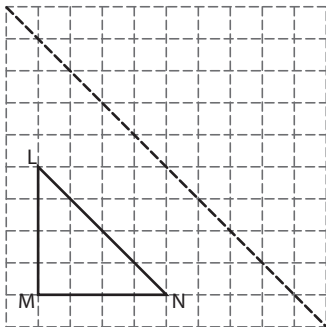

5)

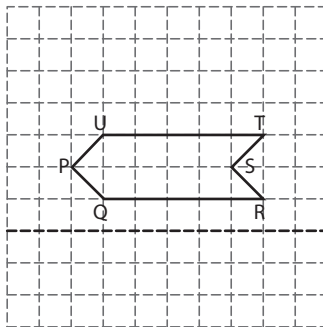

6)

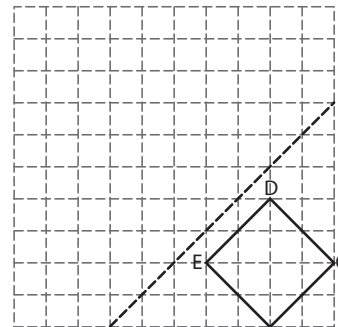

7)

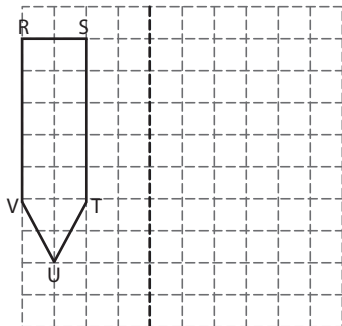

8)

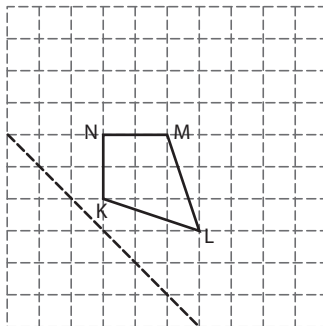

9)

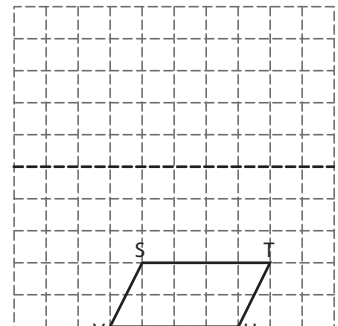

10)

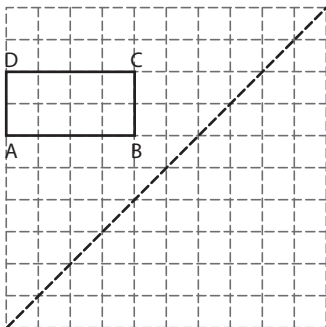

11)

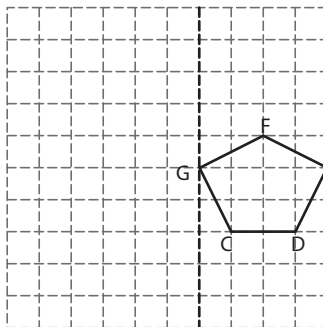

12)

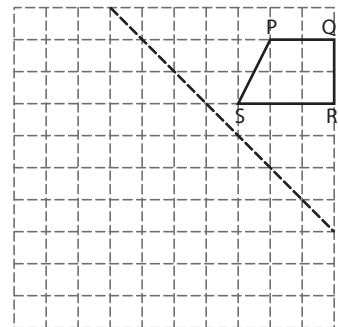

Answer key

Mirror Images

Graph the image of the given figure across the mirror line.

1)

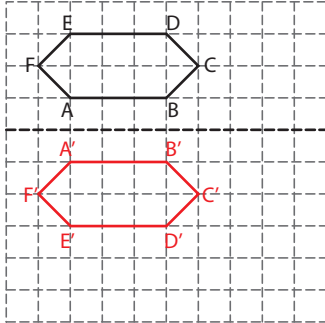

2)

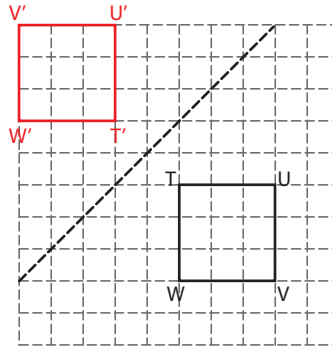

3)

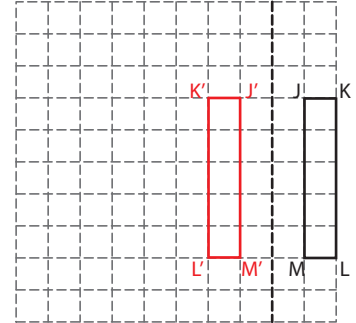

4)

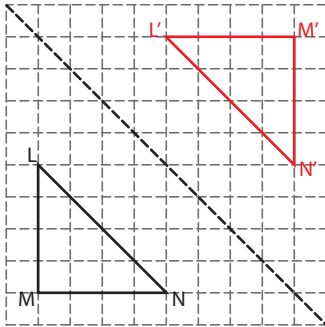

5)

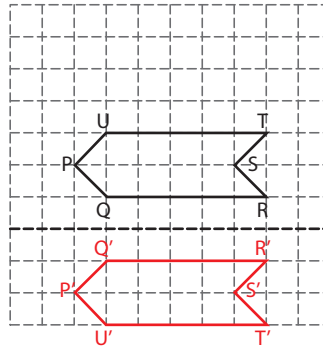

6)

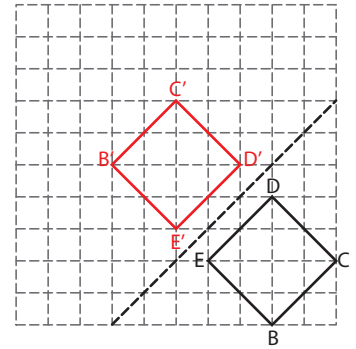

7)

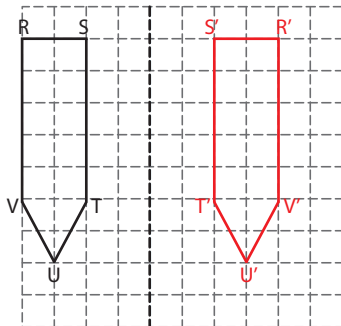

8)

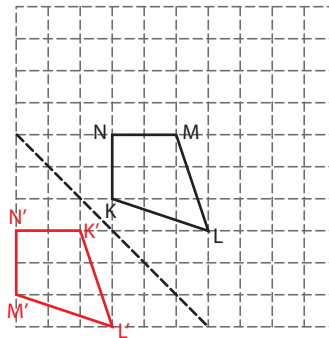

9)

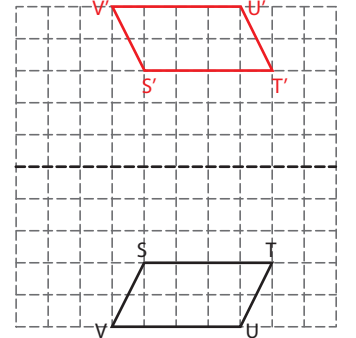

10)

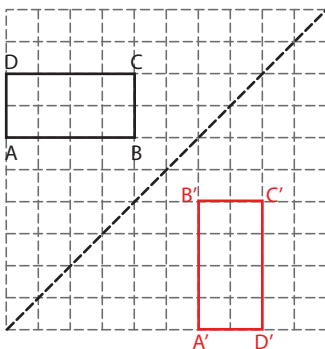

11)

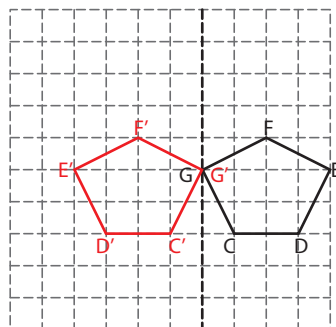

12)

