

Volume: Prisms & Cylinders

L1ES1

Find the exact volume of each shape.

1)

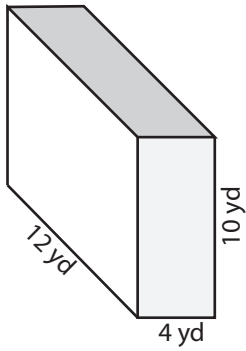

Volume = _____

2)

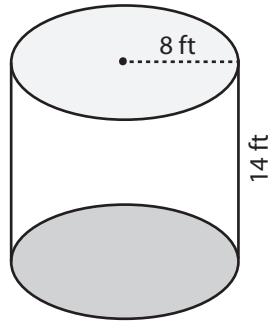

Volume = _____

3)

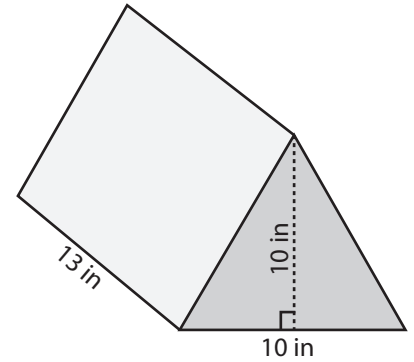

Volume = _____

4)

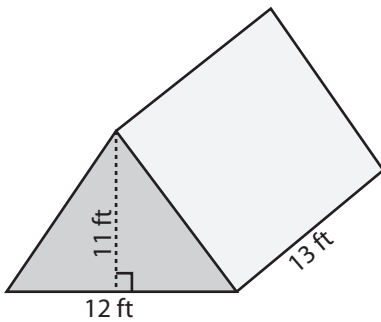

Volume = _____

5)

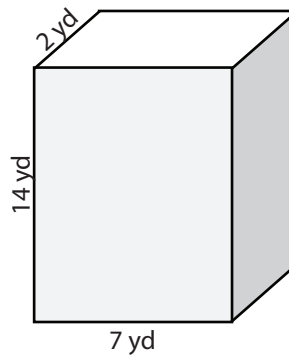

Volume = _____

6)

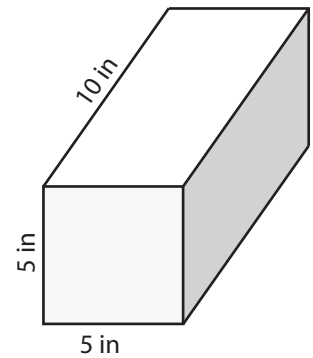

Volume = _____

7)

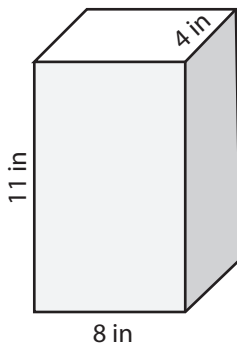

Volume = _____

8)

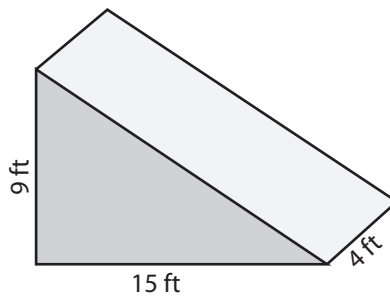

Volume = _____

9)

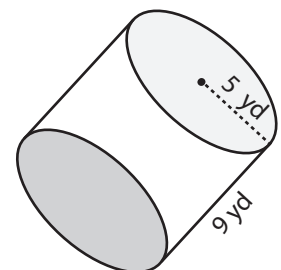

Volume = _____

Answer Key**Volume: Prisms & Cylinders**

L1ES1

Find the exact volume of each shape.

1)

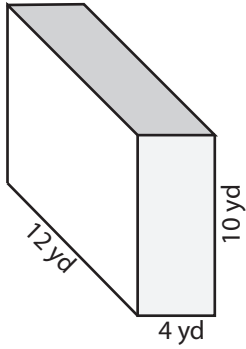

Volume = 480 yd³

2)

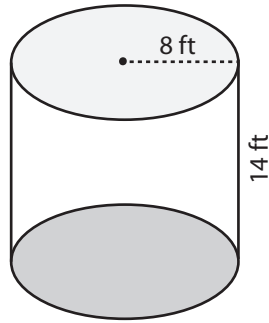

Volume = 896π ft³

3)

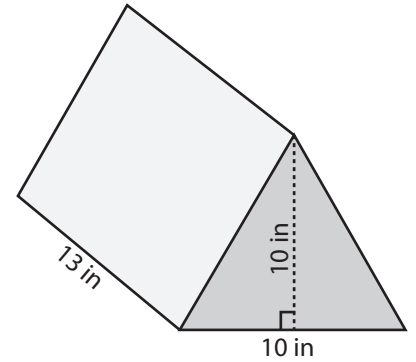

Volume = 650 in³

4)

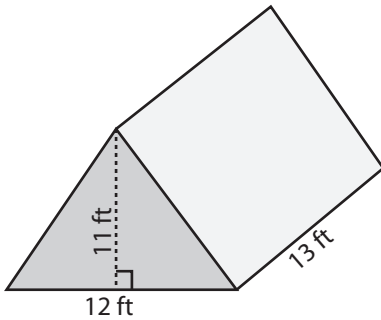

Volume = 858 ft³

5)

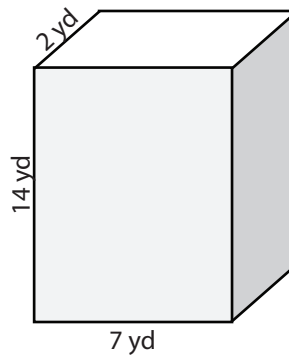

Volume = 196 yd³

6)

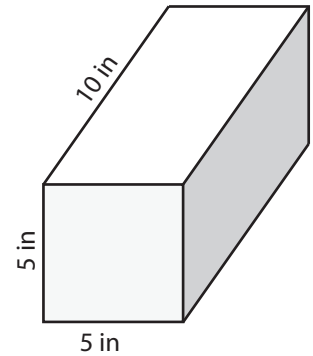

Volume = 250 in³

7)

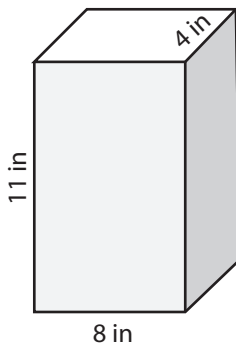

Volume = 352 in³

8)

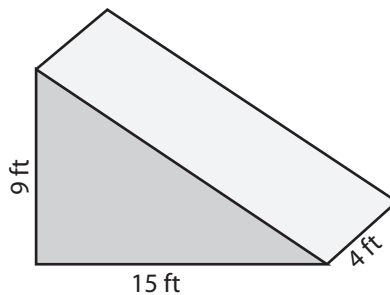

Volume = 270 ft³

9)

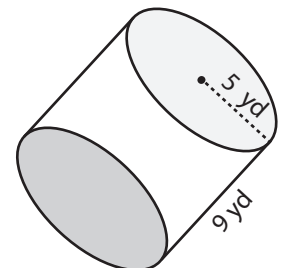

Volume = 225π yd³