

Volume of Rectangular Pyramid

Find the volume of each rectangular pyramid. Round the answer to two decimal places.

1)

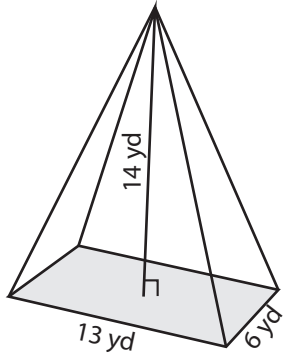

Volume = _____

2)

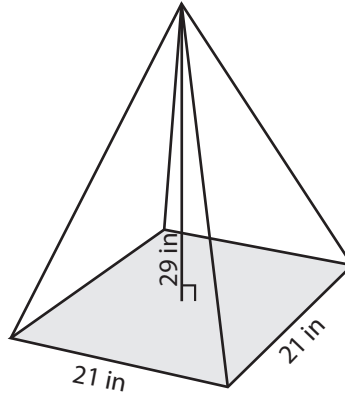

Volume = _____

3)

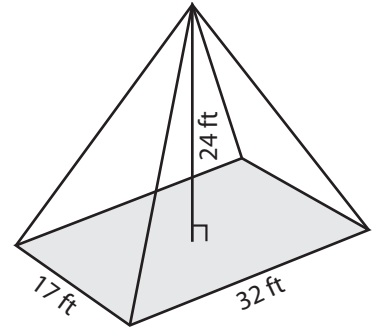

Volume = _____

4)

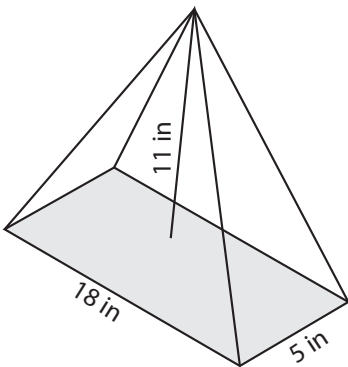

Volume = _____

5)

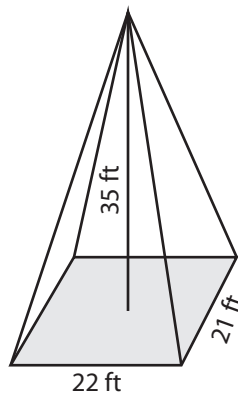

Volume = _____

6)

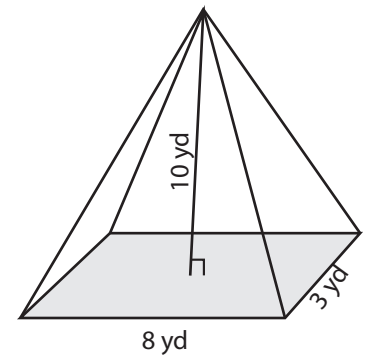

Volume = _____

7)

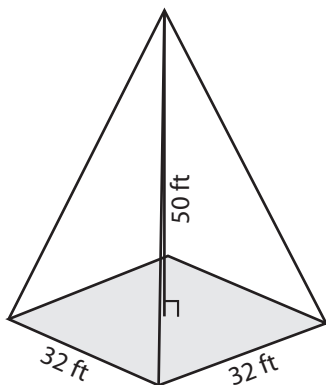

Volume = _____

8)

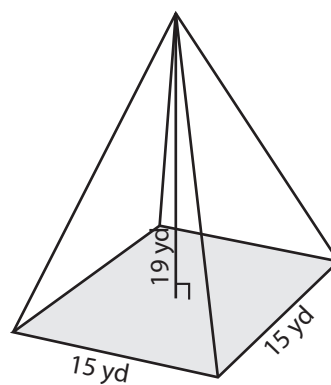

Volume = _____

9)

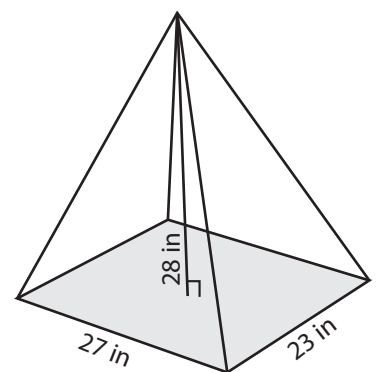

Volume = _____

Answer Key**Volume of Rectangular Pyramid**

Sheet 1

Find the volume of each rectangular pyramid. Round the answer to two decimal places.

1)

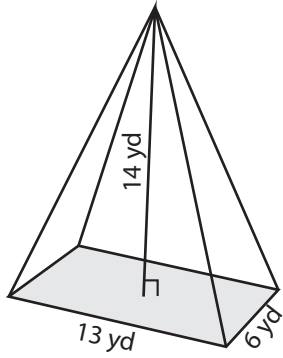

Volume = 364 yd³

2)

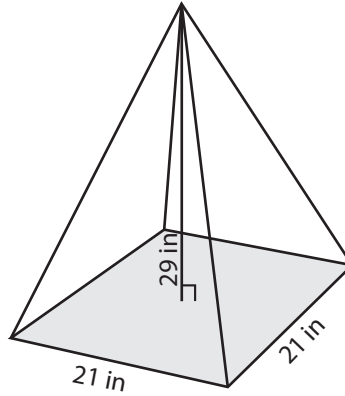

Volume = 4263 in³

3)

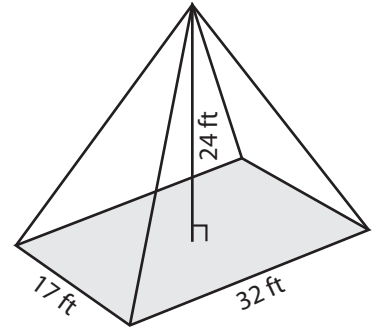

Volume = 4352 ft³

4)

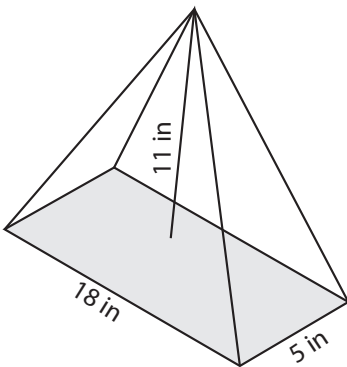

Volume = 330 in³

5)

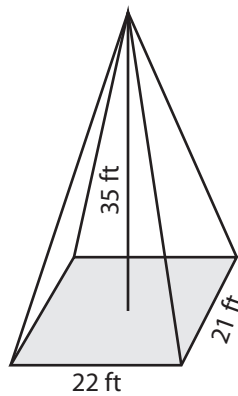

Volume = 5390 ft³

6)

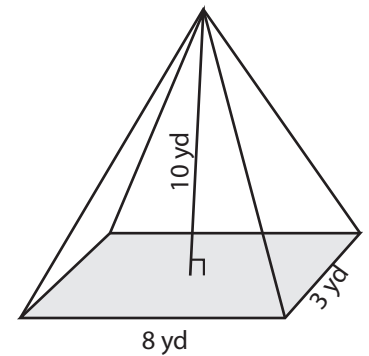

Volume = 80 yd³

7)

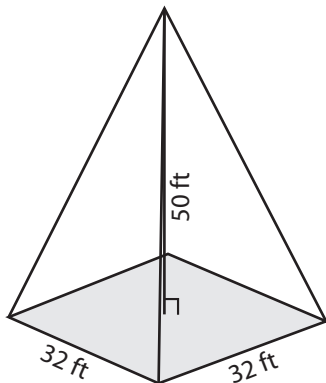

Volume = 17066.67 ft³

8)

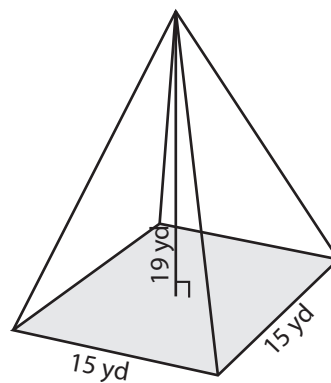

Volume = 1425 yd³

9)

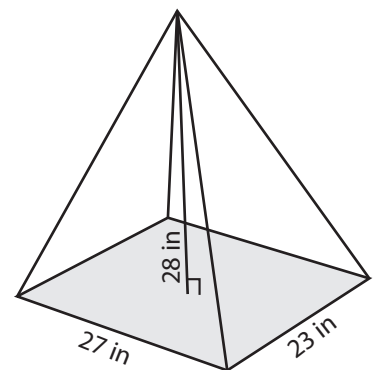

Volume = 5796 in³