

Balancing Scale - Customary Units

DS2

Calculate the unknown weight to balance each scale.

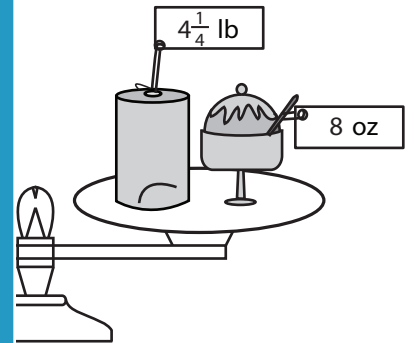
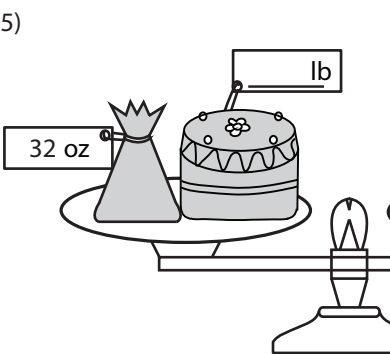
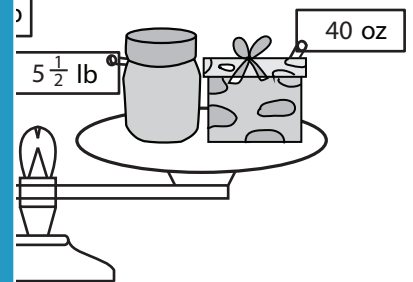
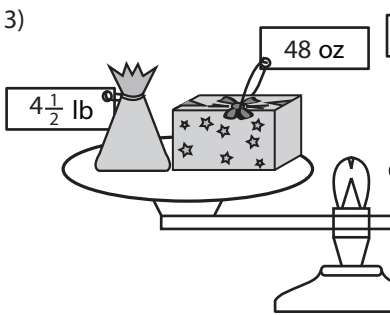
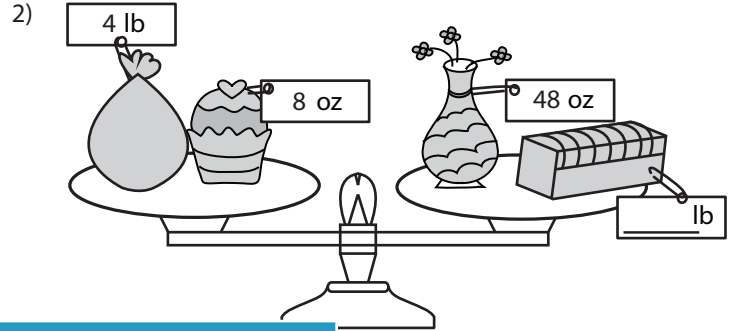
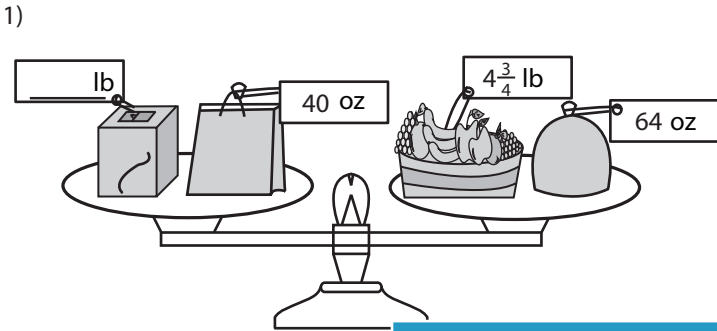

PREVIEW

Access the largest collection of worksheets for just **\$19.95** per year!

Members, please log in to download this worksheet.

Log in

Not a member? Please sign up to gain complete access.

Sign up

www.mathworksheets4kids.com

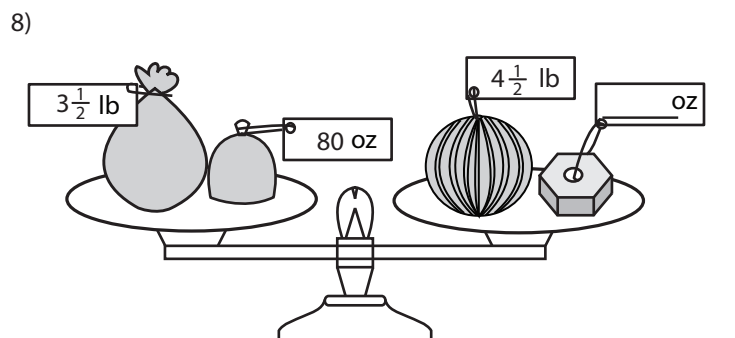
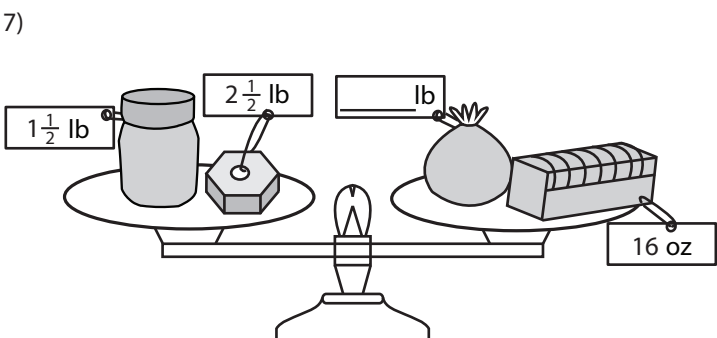

Balancing Scale - Customary Units

DS2

Calculate the unknown weight to balance each scale.

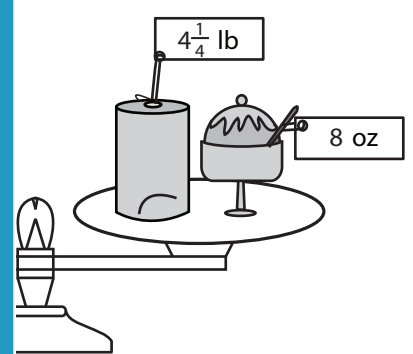
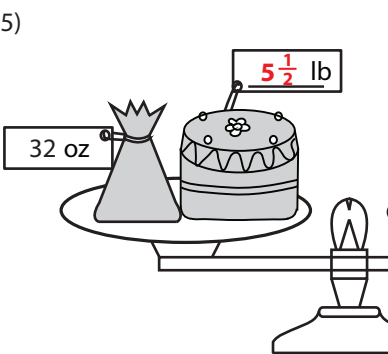
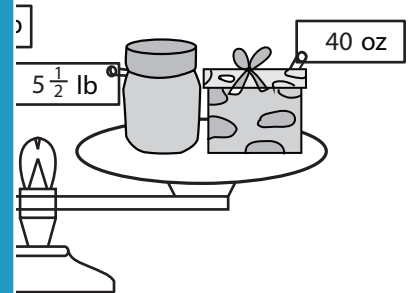
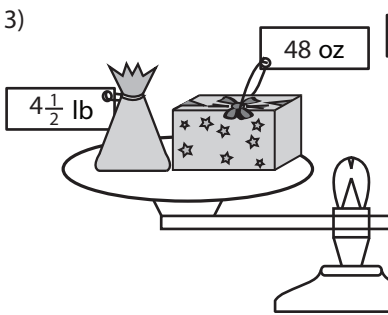
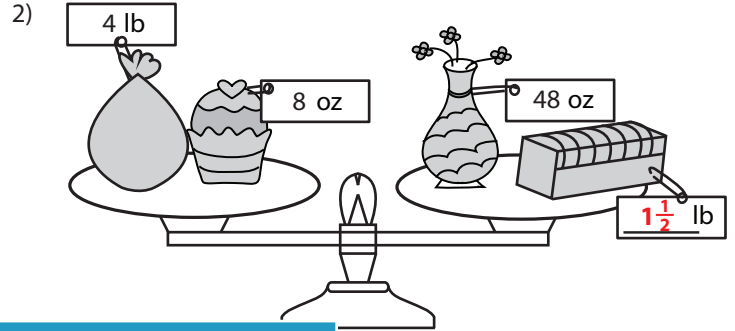
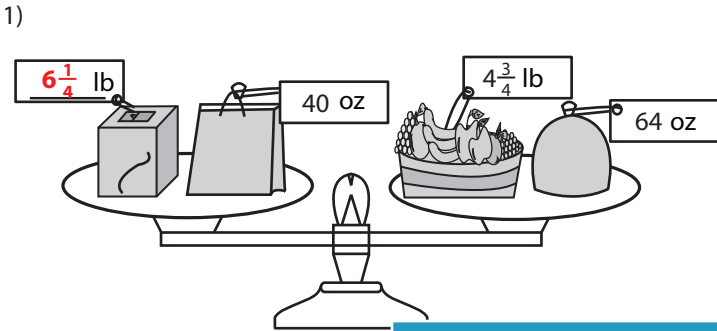

PREVIEW

Access the largest collection of
worksheets for just **\$19.95** per year!

Members, please
log in to
download this
worksheet.

Log in

Not a member?
Please sign up to
gain complete
access.

Sign up

www.mathworksheets4kids.com

