

# Color the Coins

Color the coins required to buy the object.

1)



2)

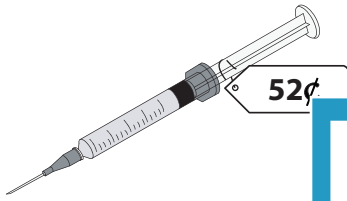

3)



4)

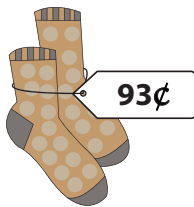

5)

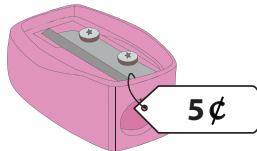

6)

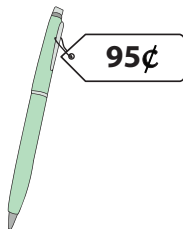

**PREVIEW**

Gain complete access to the largest collection of worksheets in all subjects!

Members, please log in to download this worksheet.

Not a member? Please sign up to gain complete access.

[www.mathworksheets4kids.com](http://www.mathworksheets4kids.com)

# Color the Coins

Color the coins required to buy the object. **(Answers may vary)**

1)



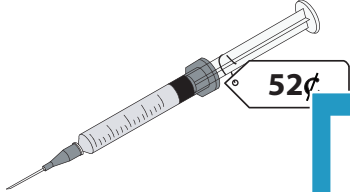

2)





3)

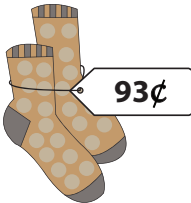



4)

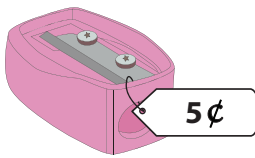

5)

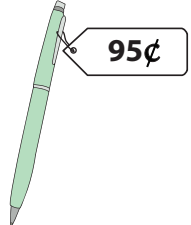
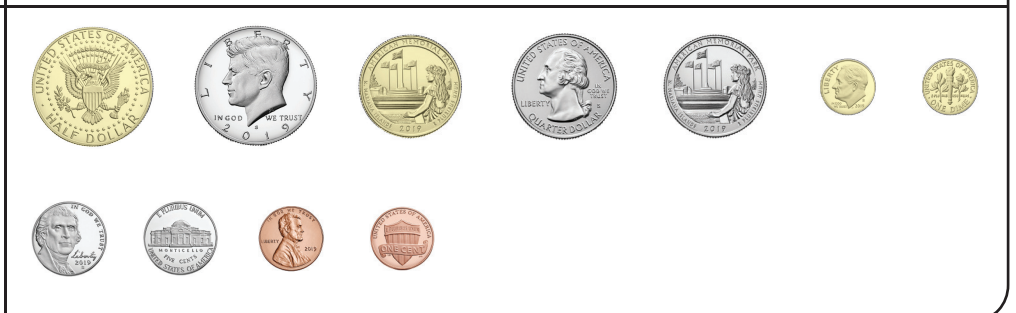

6)

**PREVIEW**

Gain complete access to the largest collection of worksheets in all subjects!

Members, please log in to download this worksheet.

Not a member? Please sign up to gain complete access.

[www.mathworksheets4kids.com](http://www.mathworksheets4kids.com)