

Name : _____

Angles Around a Point

MS1

Find the measure of each unknown angle.

1)

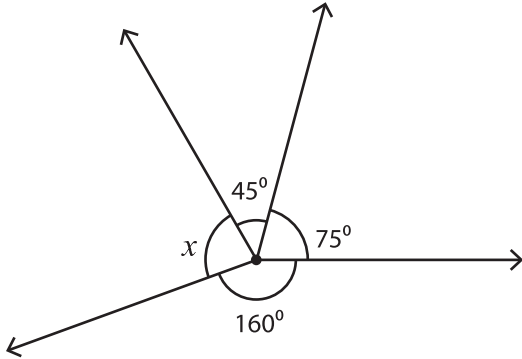

$x =$ _____

2)

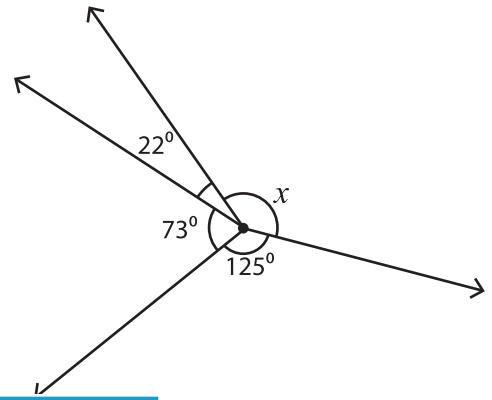

$=$ _____

3)

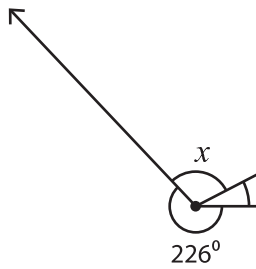

$x =$ _____

PREVIEW
Gain complete access to the largest collection of worksheets in all subjects!

Members, please log in to download this worksheet.

Not a member? Please sign up to gain complete access.

www.mathworksheets4kids.com

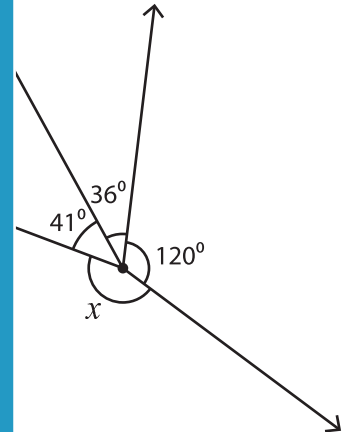

$=$ _____

5)

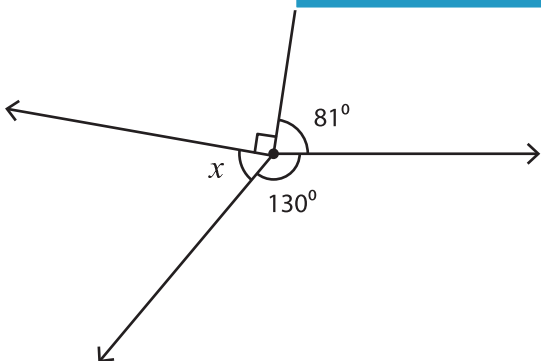

$x =$ _____

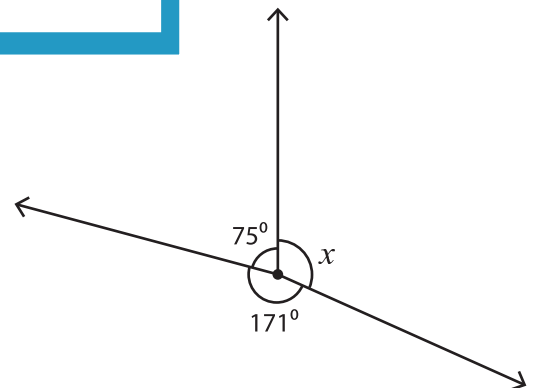

$x =$ _____