

Translation of Shapes

Graph the image of each shape using the translation given.

1) 5 units down and 4 units right

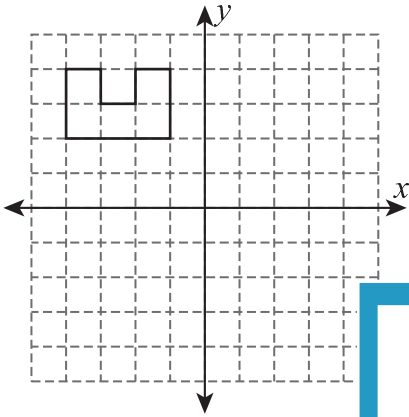

2) 2 units left and 6 units down

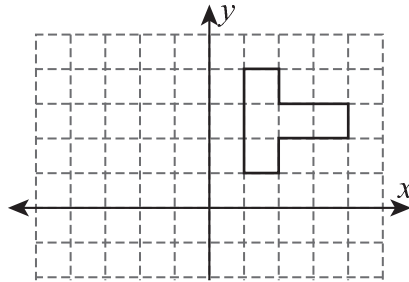

3) 7 units left

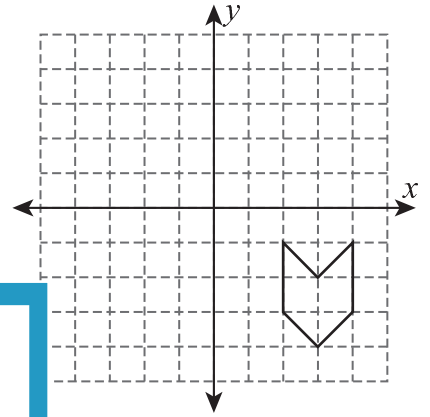

4) 2 units left and 3 units up

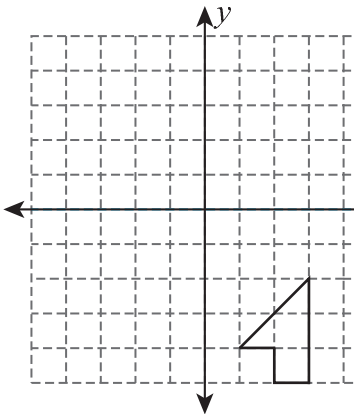

5) 3 units right and 5 units up

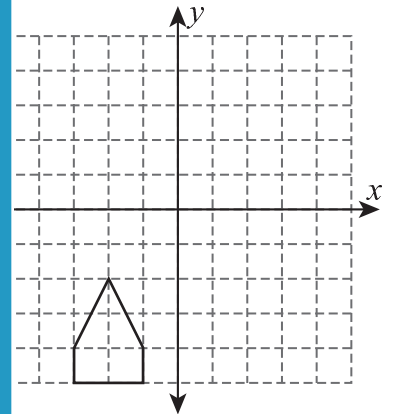

7) 3 units up and 1 unit left

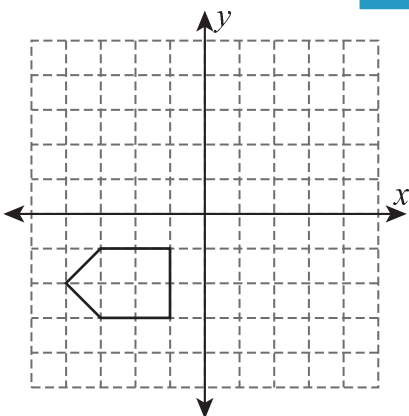

8) 2 units down and 4 units left

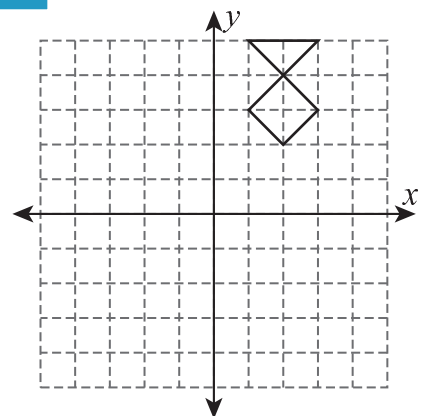
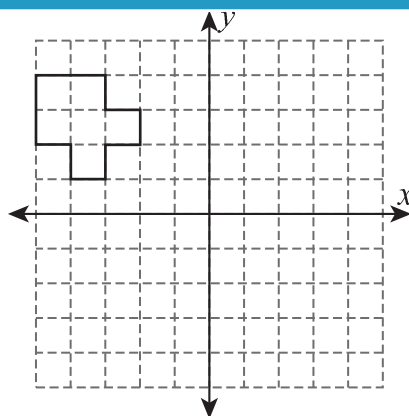

PREVIEW

Gain complete access to the largest collection of worksheets in all subjects!

Members, please log in to download this worksheet.

Not a member? Please sign up to gain complete access.

www.mathworksheets4kids.com