

Balancing Scale - Metric Units

DS2

Calculate the unknown weight to balance each scale.

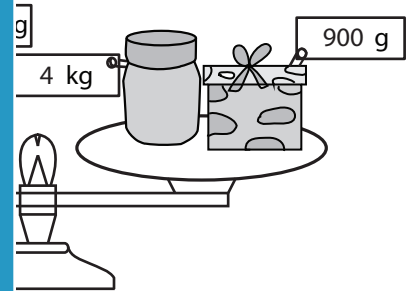
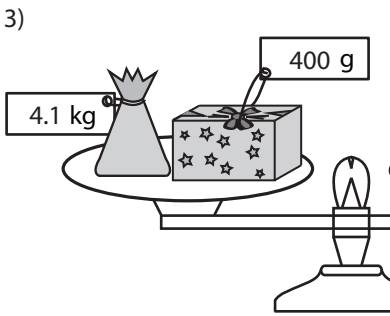
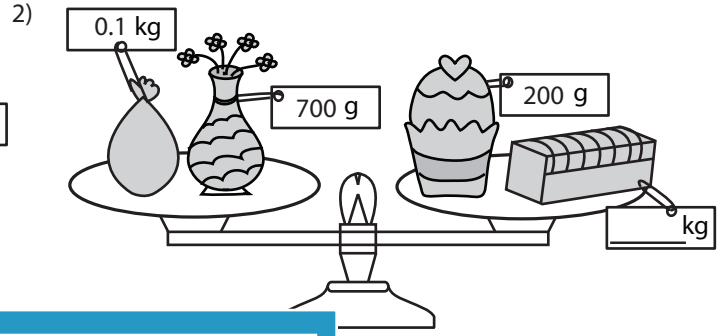
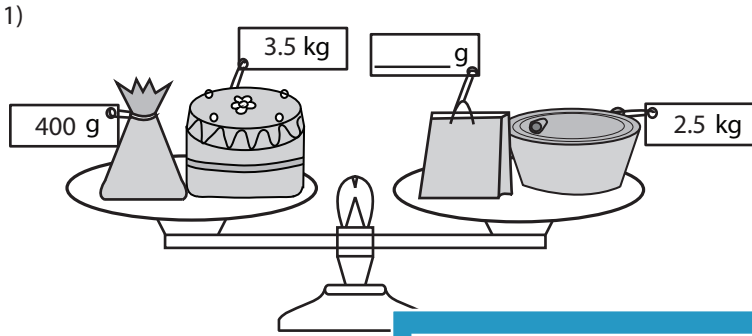

PREVIEW

Gain complete access to the largest collection of worksheets in all subjects!

Members, please log in to download this worksheet.

Not a member? Please sign up to gain complete access.

www.mathworksheets4kids.com

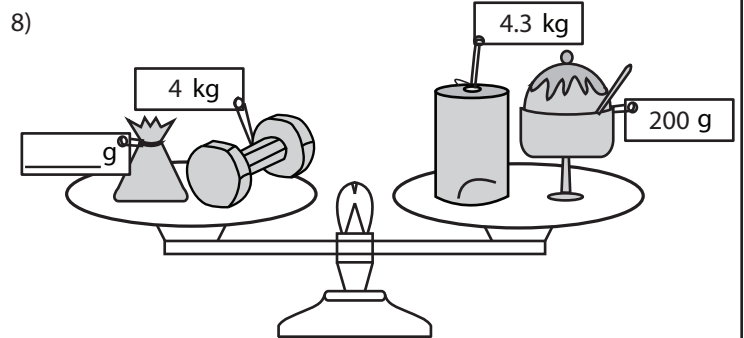
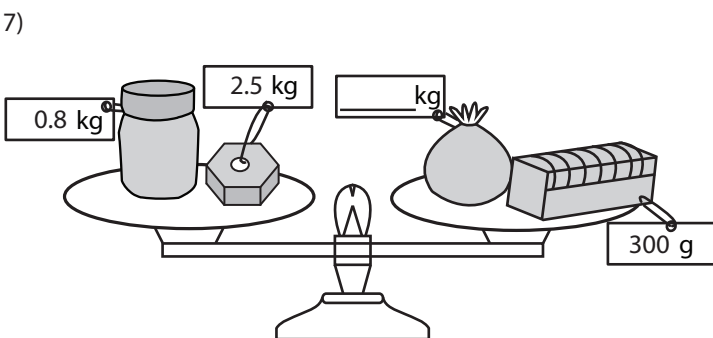
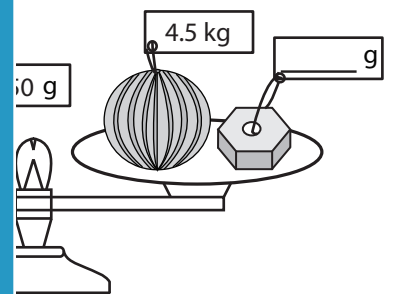
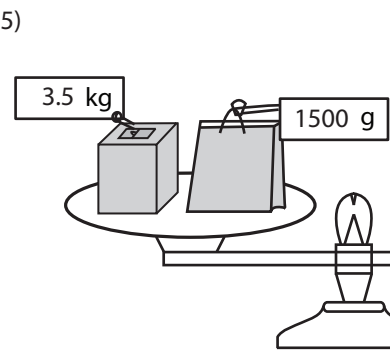

Balancing Scale - Metric Units

DS2

Calculate the unknown weight to balance each scale.

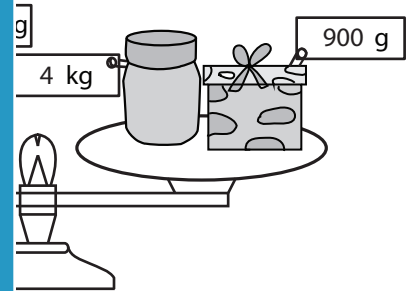
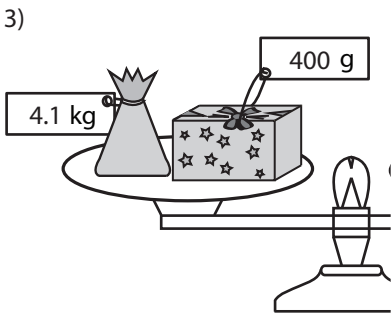
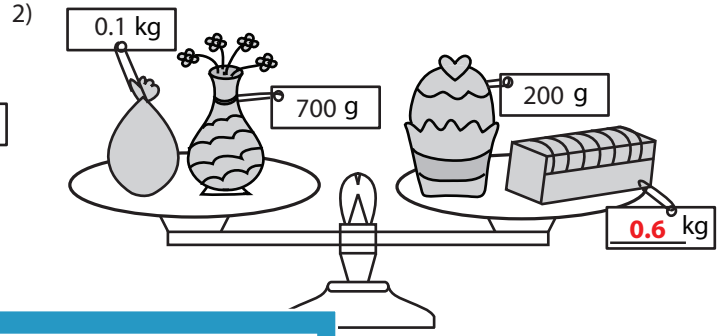
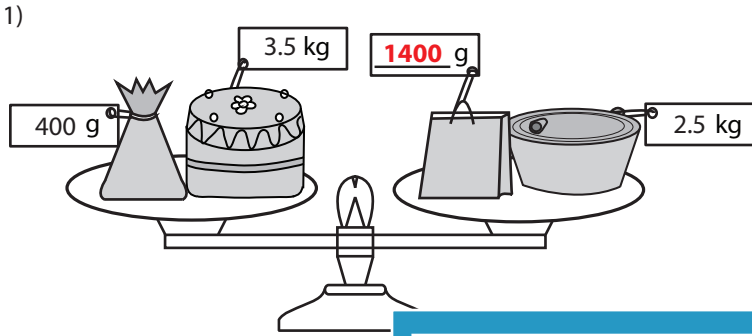

PREVIEW

Gain complete access to the largest collection of worksheets in all subjects!

Members, please log in to download this worksheet.

Not a member? Please sign up to gain complete access.

www.mathworksheets4kids.com

